

Data delivery – Schemas – Employer's separate reports 2027

Incomes Register Unit

Version history

Version	Date	Description
1.0	29/5/2026	Published a version of the document containing the 2027 changes to data content. The changes apply when the payment date of the income is on 1 January 2027 or later.
		A new data group "Employee groups" has been added. Processing rule of Transactions -data group has been modified. Guidance for Reporting period (PaymentMonth) has been clarified.
		A validation rule has been added for the Email Address field in the (ContactPersons) data group.



CONTENTS

1	General	4
1.1	Schema	4
1.2	Character set	4
1.3	Dates and times	6
1.4	Document reading instructions	7
1.5	Changes to the processing rules and data contents in 2020	7
2	Employer's separate reports (PayerSummaryReportsToIR)	8
2.1	Record data (DeliveryData)	10
2.2	Contact persons for the record (ContactPersons)	15
2.3	Payer details (Payer)	16
2.4	Payer identifiers (PayerIds)	18
2.5	Basic payer details (PayerBasic)	20
2.6	Payer's address (Address)	22
2.7	Payer's suborganisations (SubOrgs)	24
2.8	Other payer details (PayerOther)	26
2.9	Earnings-related pension insurances (PensionInsurances)	27
2.10	Occupational accident insurances (AccidentInsurances)	28
2.11	Reports data (Reports)	30
2.12	Service data (ReportData)	31
2.13	Reporting period (PaymentMonth)	33
2.14	Income types (Transactions)	34
2.15	Employee groups (EmployeeGroups)	35



1 GENERAL

1.1 Schema

Employer's separate reports are submitted to the Incomes Register using the **PayerSummaryReportsToIR** schema.

The namespaces of the schema are as follows:

File name	Prefix	Namespace
	xmlns:xs	http://www.w3.org/2001/XMLSchema
PayerSummaryReportsToIR.xsd	xmlns:psrtir	http://www.tulorekisteri.fi/2017/1/PayerSummaryReportsToIR
PayerSummaryReportsToIRTypes.xsd	xmlns:psrtirt	http://www.tulorekisteri.fi/2017/1/PayerSummaryReportsToIRTypes
IRCommonTypes.xsd	xmlns:irct	http://www.tulorekisteri.fi/2017/1/IRCommonTypes
xmldsig-core-schema.xsd	xmlns:ds	http://www.w3.org/2000/09/xmldsig#

Empty elements are not allowed in the messages. If an element receives no value, the element is left out of the message entirely. Empty character strings are also not allowed, i.e., the minimum length of all values is 1.

1.2 Character set

The schemas of the Incomes Register use UTF-8, which is the default character set of XML. The file must not contain the Byte Order Mark (BOM) character.

The following table presents the requirements for the conversion of special characters appearing in messages.

Character	Description	Presentation format as an entity
&	ampersand	& conversion is mandatory
<	less than	< conversion is mandatory
>	greater than	> conversion is not mandatory, but conforms with best practices
'	apostrophe	' conversion is not mandatory, but conforms with best practices
"	quotation mark	" conversion is not mandatory, but conforms with best practices



--	double hyphen	This character must not appear in an XML file
/*	slash asterisk	This character must not appear in an XML file
&#	ampersand hash	This character must not appear in an XML file

A limited character set is allowed for **reference data**. The allowed characters for the reference data listed below are the numbers 0-9, the letters a-z and A-Z and the symbols "_", "-" and ".".

- Record owner's record reference (DeliveryId)
- Payer's report reference (ReportId)
- Subscriber's primary subscription reference (MainSubscriptionId)
- Subscriber's secondary subscription reference (SubscriptionId)
- Sender's message reference (MessageId)

In the following data items, upper and lowercase characters are significant:

- Country codes in all data groups (for example, "DE" is interpreted to be a different code than "De").
- Customer IDs in all data groups (for example, "150172-999H" is interpreted to be a different ID than "150172-999h").

The following table shows the non-printable whitespace characters that are not to be used in the Identifier (Code):

Unicode-merkki	Kuvaus	Esitysmuoto entiteettinä
U+0020	Välilyönti eli Space	 tai
U+0009	Sarkainmerkki eli Tabulator		 tai 	 tai &Tab
U+00A0	Sitova välilyönti eli yhdistävä välilyönti eli No-break Space	 tai tai &NonBreakingSpace
U+180E	Mongolian Vowel Separator	᠎ tai ᠎
U+2000	En Quad	  tai  
U+2001	Em Quad	  tai  
U+2002	Puolikas, En-Väli Eli En Space	  tai   tai &ensp
U+2003	Neliö, Em-Väli Eli Em Space	  tai   tai &emsp
U+2004	Three-Per-Em Space	  tai   tai &emsp13



U+2005	Neljännnesväli eli Four-Per-Em Space	  tai   tai &emsp14
U+2006	Six-Per-Em Space	  tai  
U+2007	Figure Space	  tai   tai
U+2008	Punctuation Space	  tai   tai &puncsp
U+2009	Ohuke eli Thin Space	  tai   tai &ThinSpace
U+200A	Hieno väli eli Hair Space	  tai   tai &VeryThinSpace
U+200B	Leveydetön väli eli Zero Width Space	​ tai ​ tai &NegativeVeryThinSpace
U+202F	Kapea yhdistävä välilyönti tai kapea sitova välilyönti eli Narrow No-Break Space	  tai  
U+205F	Medium Mathematical Space	  tai   tai &MediumSpace
U+3000	Ideographic Space	　 tai 　
U+FEFF	Zero Width No-Break	﻿ tai ﻿
U+000A	Line Feed (Lf)	
 tai
 tai &NewLine
U+000B	Vertical Tabulation (Vt)	 tai
U+000C	Form Feed (Ff)	 tai 
U+000D	Carriage Return (Cr)	 tai 
U+0085	Next Line (Nel)	… tai …
U+2028	Line Separator (Ls)	  tai  
U+2029	Paragraph Separator (Ps)	  tai  

1.3 Dates and times

Dates (data type xs:date) must not include time zone information. Example of a date:

```
<StartDate>2017-05-11</StartDate>
```

Data elements containing times of day (data types xs:dateTime and xs:time) must include the time zone.



Example in the Finnish time zone (standard time, UTC+2):

```
<Timestamp>2017-05-11T08:00:00+02:00</Timestamp>
<Time>08:00:00+02:00</Time>
```

Example in UTC time (UTC+0):

```
<Timestamp>2017-05-11T6:00:00Z</Timestamp>
<Time>06:00:00Z</Time>
```

1.4 Document reading instructions

In the document diagrams, the 0 .. ∞ marking in the bottom right-hand corner of an element means that the element may appear several times, or not at all. The 1 .. ∞ marking means that the element may appear several times, but it must always appear at least once. The mandatory elements are highlighted with a solid border line and voluntary elements with a dashed border line.

In the document tables, the mandatory or voluntary nature of the elements is depicted with the following markings:

V/M	Description
V	The element is always voluntary.
M	The element is mandatory if its "parent element" is included.
V/M	The element is conditionally mandatory. The data processing rules describe the situations in which the element is mandatory.

In some elements, messages use a limited range of values, i.e. codes. The possible values for these codes are described in the "Codes" and "Codes – Income types" documents. This document refers to the values presented in the codesets using the term "codes".

1.5 Changes to the processing rules and data contents in 2020

The changes to the processing rules and data contents included in the annual changes for 2022 will be in effect according to the reporting period. The new data contents and the new processing rules will be applied to reports in which the reporting period is January 2022 or later. If the payment date is earlier than 1 January 2022, the schema description of the year of the payment date will be applied.

If the record contains several reports, each report processed according to the processing rules for the reporting period of that report. If any of the record-level checks fail, the entire record will be rejected.



2 EMPLOYER'S SEPARATE REPORTS (PAYERSUMMARYREPORTSTOIR)

The general structure of a record containing employer's separate reports submitted to the Incomes Register is as follows:

Data group name	Type	V/M
Record data (DeliveryData)	psrtirt:DeliveryData	M
Contact persons for the record (ContactPersons)	psrtirt:ContactPersons	M
Payer details (Payer)	psrtirt:Payer	M
Payer identifiers (PayerIds)	psrtirt:PayerIds	V/M
Basic payer details (PayerBasic)	psrtirt:PayerBasic	V/M
Payer's address (Address)	psrtirt:Address	V/M
Payer's suborganisations (SubOrgs)	psrtirt:SubOrgs	V/M
Earnings-related pension insurances (PensionInsurances)	psrtirt:PensionInsurances	V
Occupational accident insurances (AccidentInsurances)	psrtirt:AccidentInsurances	V
Other payer details (PayerOther)	psrtirt:PayerOther	V
Reports data (Reports)	psrtirt:Reports	M
Report (Report)	psrtirt:Report	M
Service data (ReportData)	psrtirt:ReportData	M
Reporting period (PaymentMonth)	psrtirt:PaymentMonth	M
Income types (Transactions)	psrtirt:Transactions	V/M
Income type data (Transaction)	psrtirt:Transaction	M
General details on the income type (TransactionBasic)	psrtirt:TransactionBasic	M
Employee groups (EmployeeGroups)	psrtirt:EmployeeGroups	V/M
Time range (TimeSpan)	psrtirt:TimeSpan	M
Employee group (EmployeeGroup)	psrtirt:EmployeeGroup	M
Pay gaps (WageDifferences)	psrtirt:WageDifferences	V/M
Allekirjoitus (Signature)	xsig:SignatureType	V/M





2.1 Record data (DeliveryData)

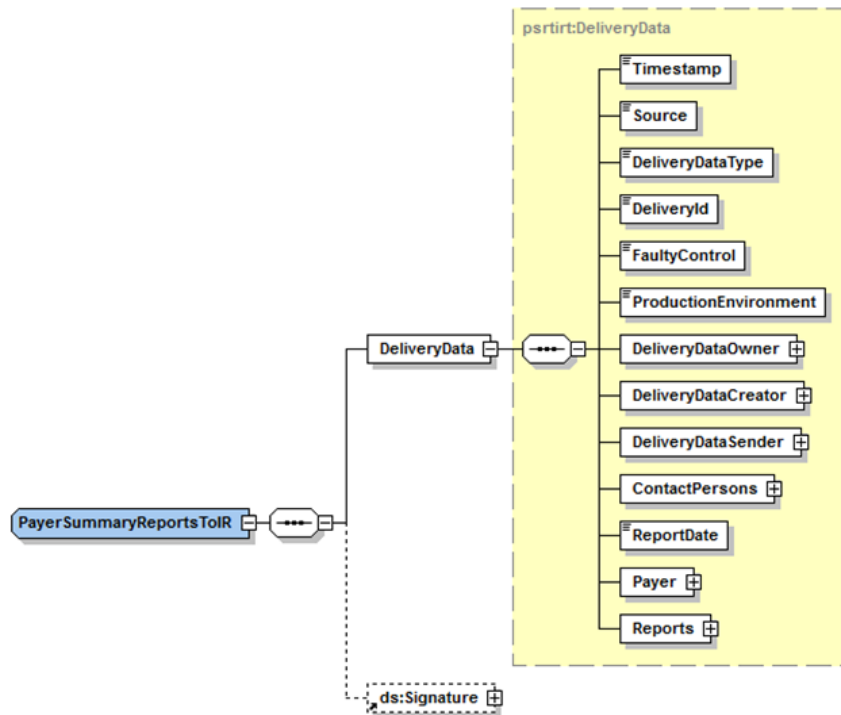

Data group details:

Data designation	Type	Allowed values	V/ M	Processing rule
Record data (DeliveryData)	psrtirt:DeliveryData		M	
Time of record creation (Timestamp)	xs:dateTime		M	
Data source (Source)	irct:String30		M	



Data designation	Type	Allowed values	V/ M	Processing rule
Record type (DeliveryDataType)	xs:int	Codes: QueryDataType and value 101 from it	M	
Record owner's (payer's) record reference (DeliveryId)	irct:String40		M	The record owner's record reference must uniquely identify all records of a specific record owner (DeliveryDataOwner) containing employer's separate reports (DeliveryDataType=101).
Rule for processing invalid data (reports) (FaultyControl)	xs:int	Codes: FaultyControl	M	If the record contains invalid reports, this entry determines whether to reject only the invalid reports in the record or the entire record.
Production environment (ProductionEnvironment)	irct:trueOrFalse	Codes: ProductionEnvironm ent	M	If the value is "true", the data must have been delivered to the Incomes Register's production environment. If the value is "false", the data must have been delivered to the Incomes Register's test environment.
Record owner (DeliveryDataOwner)	psrtirt:Id		M	<p>Processing rules related to data items Record owner, Record creator and Record submitter:</p> <p>The payer has a customer ID and the payer reports the data: At least one identifier has been specified in the data group Payer identifiers. The data item <i>Record owner</i> must be one of the payer identifiers. If a business ID has been specified in the data group Payer identifiers, it must be specified as the Record owner. The Record owner (= payer) must be specified as the <i>Record creator</i>. The Record owner (= payer) must be specified as the <i>Record submitter</i>.</p> <p>The payer has a customer ID and the service provider submits the data on behalf of the payer: At least one identifier has been specified in the data group Payer identifiers. The data item <i>Record owner</i> must be one of the payer</p>



Data designation	Type	Allowed values	V/ M	Processing rule
				<p>identifiers. If a business ID has been specified in the data group Payer identifiers, it must be specified as the Record owner. The identifier of the service provider must be specified as the <i>Record creator</i>. If the service provider has a business ID, it must be specified. It must be specified in the Incomes Register that the service provider has the right to submit records on behalf of others.</p> <p>The Record creator (= service provider) must be specified as the <i>Record submitter</i>.</p> <p>The payer has no customer ID and the service provider submits the data on behalf of the payer:</p> <p>The value of the data item "The payer does not have a customer ID" is "true".</p> <p>The identifier of the service provider must be specified as the <i>Record owner</i>. If the service provider has a business ID, it must be specified. It must be specified in the Incomes Register that the service provider has the right to submit records on behalf of others.</p> <p>The Record owner (= service provider) must be specified as the <i>Record creator</i>.</p> <p>The Record owner (= service provider) must be specified as the <i>Record submitter</i>.</p>
Identifier type (Type)	xs:int	Codes: IdType	M	
Identifier (Code)	irct:String30		M	<p>If the "Identifier type" is "Business ID", the identifier must exist (according to information from the Business Information System (YTJ)).</p> <p>If the "Identifier type" is "Finnish Personal Identification Number", the identifier must exist (according to information from the Population Information System (VTJ)).</p>



Data designation	Type	Allowed values	V/ M	Processing rule
				<p>If the "Identifier type" is other than "Business ID" or "Finnish Personal Identification Number" identifier must not be Finnish personal identification number or Business ID.</p> <p>The data must not begin or end with non-printable whitespace characters, such as spaces. The data cannot contain non-printable whitespace characters, excluding space.</p>
Country code (CountryCode)	irct:String2	A two-character code in accordance with the ISO 3166 country codes. If the country is unknown, the value "99" is entered.	V/ M	<p>Mandatory data if "Identifier type" is other than "Business ID" or "Finnish Personal Identification Number".</p> <p>Country code "FI" must not be specified, if the specified "Identifier type" is other than "Business ID", "Finnish Personal Identification Number" or "Other identifier".</p> <p>If the "Identifier type" is set as "Finnish Personal Identification Number" or "Finnish Business ID", the country code can only be "FI".</p>
Country name (CountryName)	irct:String70		V/ M	Mandatory data if "Country code" is "99".
Record creator (DeliveryDataCreator)	psrtirt:Id		M	The processing rules for Identifier type, Identifier, Country code and Country name are the same as in the Record owner (DeliveryDataOwner) data group.
Record submitter (DeliveryDataSender)	psrtirt:Id		M	The processing rules for Identifier type, Identifier, Country code and Country name are the same as in the Record owner (DeliveryDataOwner) data group.
Contact persons for the record (ContactPersons)	psrtirt:ContactPersons		M	
Reporting date (Reportdate)	xs:date		M	<p>The date must be the current date or earlier.</p> <p>The date must not be earlier than 1 January 2019.</p>
Payer details (Payer)	psrtirt:Payer		M	



Data designation	Type	Allowed values	V/ M	Processing rule
Reports data (Reports)	psrtirt:Reports		M	
Signature (Signature)	xsig:SignatureType		V/ M	<p>The electronic signature of the record is delivered in this data group. The record must be signed using the certificate of the party specified as the Record creator.</p> <p>The element is not allowed with records submitted through the upload/download service.</p>



2.2 Contact persons for the record (ContactPersons)

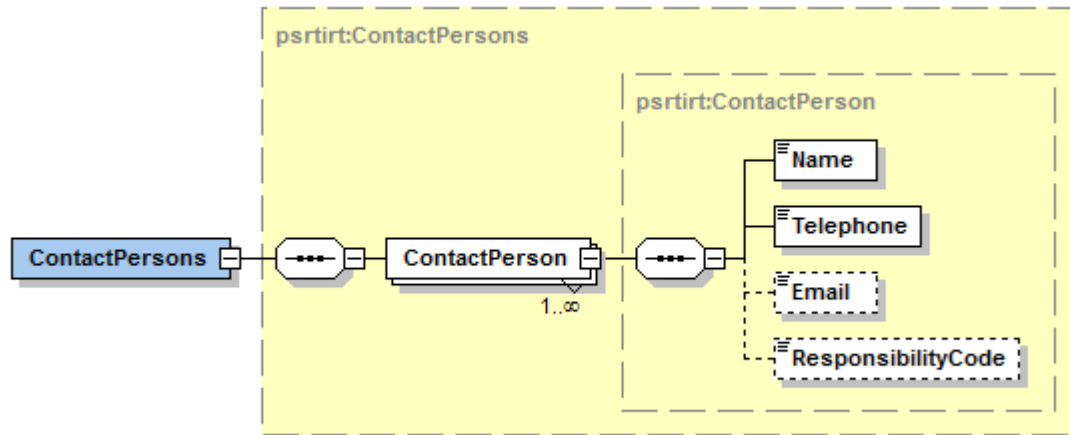

Data group details:

Data designation	Type	Allowed values	V/ M	Processing rule
Contact persons for the record (ContactPersons)	psrtirt:ContactPersons		M	
Contact person for the record (ContactPerson)	psrtirt:ContactPerson		M	There may be several contact persons.
Name (Name)	irct:String200		M	
Telephone number (Telephone)	irct:String40		M	
E-mail address (Email)	irct:String70		V	An email address must contain one at sign (@). Before the @ sign, there must be at least one character (A–Z, a–z, 0–9 or ._%+-). After the @ sign, there must be at least one character (A–Z, a–z, 0–9, . or -) followed by a dot (.) and 2–63 letters (A–Z or a–z).
Field of responsibility (ResponsibilityCode)	xs:int	Codes: ResponsibilityCode	V	





2.3 Payer details (Payer)

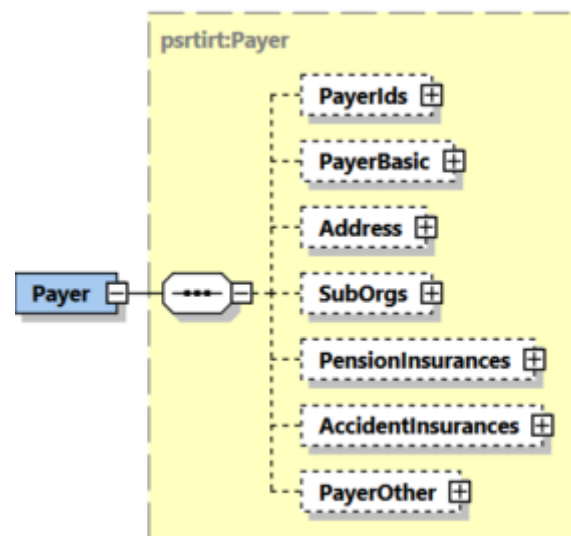

Data group details:

Data designation	Type	Allowed values	V/ M	Processing rule
Payer details (Payer)	psrtirt:Payer		M	
Payer identifiers (PayerIds)	psrtirt:PayerIds		V/ M	If multiple identifiers have been given in the data group, the identifier types cannot be the same. The same combination of identifier type and country code cannot be entered multiple times. There can only be one identifier type of "Finnish Personal Identification Number" or "Finnish Business ID" in the data group.
Basic payer details (PayerBasic)	psrtirt:PayerBasic		V/ M	
Payer's address (Address)	psrtirt:Address		V/ M	



Data designation	Type	Allowed values	V/ M	Processing rule
Payer's suborganisations (SubOrgs)	psrtirt:SubOrgs		V/ M	
Earnings-related pension insurances (PensionInsurances)	psrtirt:PensionInsurances		V	
Occupational accident insurances (AccidentInsurance)	psrtirt:AccidentInsurances		V	
Other payer details (PayerOther)	psrtirt:PayerOther		V	



2.4 Payer identifiers (PayerIds)

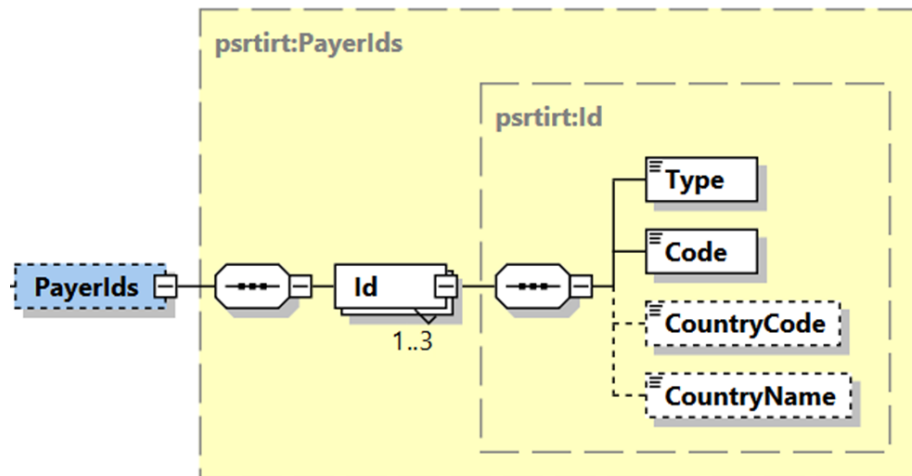

Data group details:

Data designation	Type	Allowed values	V/ M	Processing rule
Payer identifiers (PayerIds)	psrtirt:PayerIds		V/ M	Mandatory data group, if "The payer does not have a customer ID" has not been specified. If the "Action type" is "Replacement report", the data should match that of the report's previous version.
Payer's ID (Id)	psrtirt:Id		M	A payer can be given up to three payer identifiers. If the payer has been given both a Business ID and a Finnish Personal Identification Number, the identifiers must refer to the same customer.
Identifier type (Type)	xs:int	Codes: IdType	M	
Identifier (Code)	irct:String30		M	If the "Identifier type" is "Business ID", the identifier must exist (according to information from the Business Information System (YTJ)).



Data designation	Type	Allowed values	V/ M	Processing rule
				<p>If the "Identifier type" is "Finnish Personal Identification Number", the identifier must exist (according to information from the Population Information System (VTJ)).</p> <p>If the "Identifier type" is other than "Business ID" or "Finnish Personal Identification Number" identifier must not be Finnish personal identification number or Business ID.</p> <p>The data must not begin or end with non-printable whitespace characters, such as spaces. The data cannot contain non-printable whitespace characters, excluding space.</p>
Country code (CountryCode)	irct:String2	A two-character code in accordance with the ISO 3166 country codes. If the country is unknown, the value "99" is entered.	V/ M	<p>Mandatory data if "Identifier type" is other than "Business ID" or "Finnish Personal Identification Number".</p> <p>Country code "FI" must not be specified, if the specified "Identifier type" is other than "Business ID", "Finnish Personal Identification Number" or "Other identifier".</p> <p>If the "Identifier type" is set as "Finnish Personal Identification Number" or "Finnish Business ID", the country code can only be "FI".</p>
Country name (CountryName)	irct:String70		V/ M	Mandatory data if "Country code" is "99".



2.5 Basic payer details (PayerBasic)

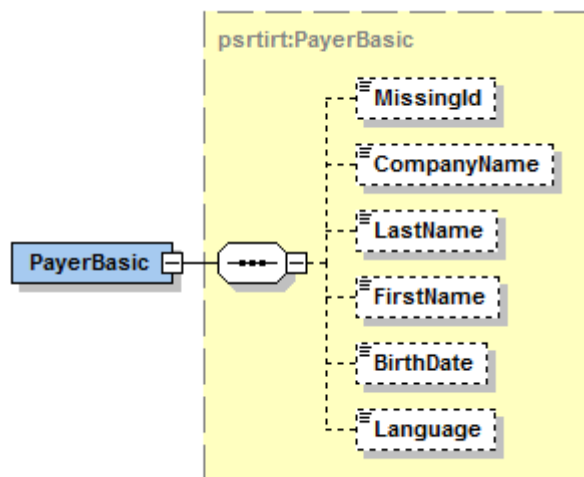

Data group details:

Data designation	Type	Allowed values	V/ M	Processing rule
Basic payer details (PayerBasic)	psrtirt:PayerBasic		V/ M	Mandatory data group, if no identifiers where "Identifier type" is "Business ID" or "Finnish Personal Identification Number" have been specified in the "Payer identifiers" data group.
The payer does not have a customer ID (MissingId)	irct:true	"true"	V/ M	Mandatory data, if no identifiers have been specified in the "Payer identifiers" data group.
Company name (CompanyName)	irct:String200		V/ M	Mandatory data in the following cases: <ul style="list-style-type: none"> No identifier where the "Identifier type" is "Business ID" or "Finnish Personal Identification Number" has been specified in the "Payer identifiers" data group, and "Last name" and "First name" have not been specified.



Data designation	Type	Allowed values	V/ M	Processing rule
				<ul style="list-style-type: none"> The value of "The payer does not have a customer ID" is "true", and "Last name" and "First name" have not been specified.
Last name (LastName)	irct:String200		V/ M	Mandatory data in the following cases: <ul style="list-style-type: none"> No identifier where the "Identifier type" is "Business ID" or "Finnish Personal Identification Number" has been specified in the "Payer identifiers" data group, and "Company name" has not been specified. The value of "The payer does not have a customer ID" is "true", and "Company name" has not been specified.
First name (FirstName)	irct:String100		V/ M	Checked in the same way as "Last name".
Date of birth (BirthDate)	xs:date		V/ M	Mandatory data in the following cases: <ul style="list-style-type: none"> No identifier where the "Identifier type" is "Finnish Personal Identification Number" has been specified in the "Payer identifiers" data group, and "Last name" and "First name" have been specified . The value of "The payer does not have a customer ID" is "true", and "Last name" and "First name" have been specified. <p>The date must not be later than the current date. The date must not be earlier than 1 January 1800.</p>
Contact language (Language)	xs:int	Codes: Language	V	



2.6 Payer's address (Address)

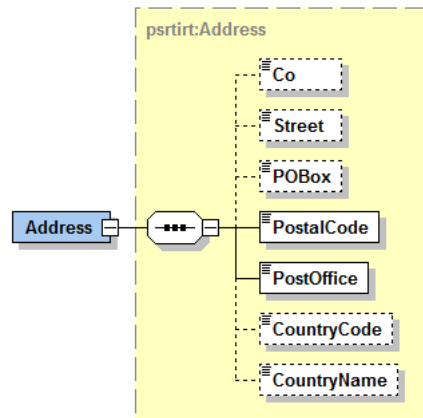

Data group details:

Data designation	Type	Allowed values	V/ M	Processing rule
Payer's address (Address)	psrtirt:Address		V/ M	Mandatory data group in the following cases: <ul style="list-style-type: none"> No identifiers where "Identifier type" is "Business ID" or "Finnish Personal Identification Number" have been specified in the "Payer identifiers" data group. The value of "The payer does not have a customer ID" is "true".
c/o (Co)	irct:String70		V	
Street address (Street)	irct:String100		V/ M	If this data group is included, either "Street address" or "P.O. Box" must be specified. Both must not be entered.
P.O. Box (POBox)	irct:String10		V/ M	If this data group is included, either "Street address" or "P.O. Box" must be specified. Both must not be entered.
Postal code (PostalCode)	irct:String20		M	
City (PostOffice)	irct:String200		M	



Data designation	Type	Allowed values	V/ M	Processing rule
Country code (CountryCode)	irct:String2	A two-character code in accordance with the ISO 3166 country codes. If the country is unknown, the value "99" is entered.	V/ M	Mandatory data in the following cases: <ul style="list-style-type: none">• No identifiers where "Identifier type" is "Business ID" or "Finnish Personal Identification Number" have been specified in the "Payer identifiers" data group.• The value of "The payer does not have a customer ID" is "true".
Country name (CountryName)	irct:String70		V/ M	Mandatory data if "Country code" is "99".



2.7 Payer's suborganisations (SubOrgs)

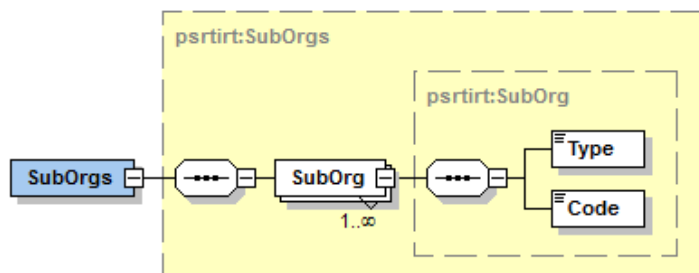

Data group details:

Data designation	Type	Allowed values	V/ M	Processing rule
Payer's suborganisations (SubOrgs)	psrtirt:SubOrgs		V/ M	Mandatory data group if a Pension provider code (PensionProvdCode) has been specified in the Earnings-related pension insurances (PensionInsurances) data group, and its value is 20, 24, 25, 29 or 30. In such a case, the payer's suborganisation whose "Suborganisation's identifier type" is "Keva's submitter codes" must be specified in the data group.
Payer's suborganisation (SubOrg)	psrtirt:SubOrg		M	A payer can have several suborganisations. A payer can have only one suborganisation, conforming to a specific Suborganisation's identifier data item. For example: A payer can have only one suborganisation whose "Suborganisation's identifier type" is "Keva's submitter codes".
Suborganisation's identifier type (Type)	xs:int	Codes: PayerSubOrgType	M	
Suborganisation identifier (Code)	irct:String20		M	If "Suborganisation's identifier type" is "Keva's submitter codes", the combination ("Suborganisation identifier", "Pension policy number") must be included in the codeset and must be valid on the date that is the value of "Payment date or other report date".



Data designation	Type	Allowed values	V/ M	Processing rule
				If "Suborganisation's identifier type" has some other value, it must be included in the specified codeset. If the codeset includes a validity period, the value must be valid on the date that is the value of "Payment date or other report date" in the specified codeset.



2.8 Other payer details (PayerOther)

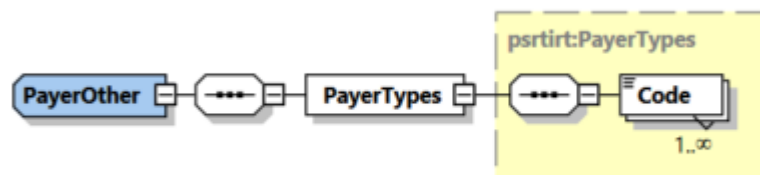

Data group details:

Data designation	Type	Allowed values	V/ M	Processing rule
Other payer details (PayerOther)	psrtirt:PayerOther		V	
Payer types (PayerTypes)	psrtirt:PayerTypes		M	
Payer type (Code)	xs:int	Codes: PayerType	M	The payer type can only be "Household", "Pool of household employers" or both.



2.9 Earnings-related pension insurances (PensionInsurances)

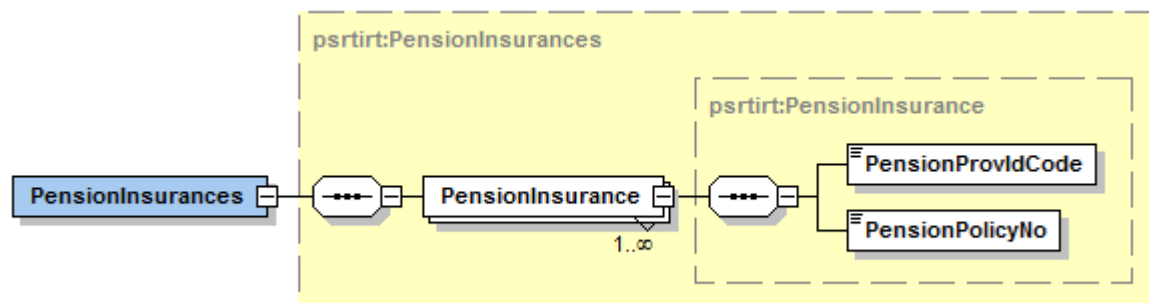

Data group details:

Data designation	Type	Allowed values	V/M	Processing rule
Earnings-related pension insurances (PensionInsurances)	psrtirt:PensionInsurances		V	If the "Action type" is "Replacement report", the data should match that of the report's previous version.
Earnings-related pension insurance (PensionInsurance)	psrtirt:PensionInsurance		M	A payer can have several earnings-related pension insurances.
Pension provider code (PensionProvdCode)	xs:int	Codes: PensionProvdCode	M	The value of the data item must be the same as the first two/five characters of the value of the Pension policy number data item.
Pension policy number (PensionPolicyNo)	irct:PensionPolicyNo	Pension policy number codes of earnings-related pension providers	M	The value must be a pension policy number conforming to the Pension policy number codes of earnings-related pension providers, and it must be valid on at least one day during the Reporting period (PaymentMonth).



2.10 Occupational accident insurances (AccidentInsurances)

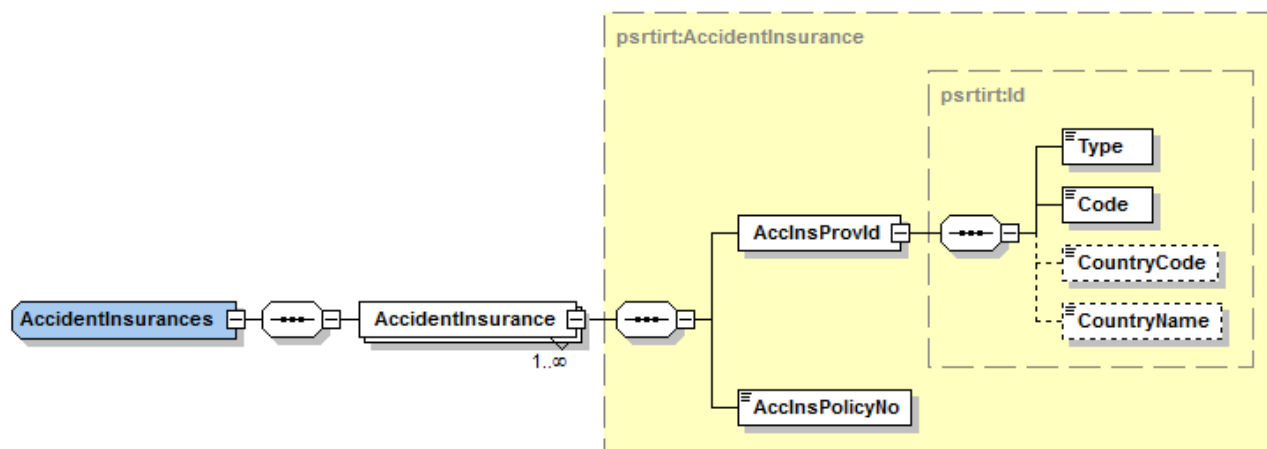

Data group details:

Data designation	Type	Allowed values	V/M	Processing rule
Occupational accident insurances (AccidentInsurances)	psrtirt:AccidentInsurances		V	If the "Action type" is "Replacement report", the data should match that of the report's previous version.
Occupational accident insurance (AccidentInsurance)	psrtirt:AccidentInsurance		M	A payer can have several occupational accident insurances.
Occupational accident insurance company identifier (AccInsProvid)	psrtirt:Id		M	
Identifier type (Type)	xs:int	Codes: IdType	M	Type of identifier must not be a "Personal Identification Number (Finnish)" or a "Foreign personal identification number"
Identifier (Code)	irct:String30		M	If the "Identifier type" is "Business ID", the identifier must exist (according to information from the Business Information System (YTJ)). If the "Identifier type" is other than "Business ID" or "Finnish Personal Identification Number" identifier must not be Finnish personal identification number or Business ID.



Data designation	Type	Allowed values	V/ M	Processing rule
				The data must not begin or end with non-printable whitespace characters, such as spaces. The data cannot contain non-printable whitespace characters, excluding space.
Country code (CountryCode)	irct:String2	A two-character code in accordance with the ISO 3166 country codes. If the country is unknown, the value "99" is entered.	V/ M	Mandatory data if "Identifier type" is other than "Business ID" or "Finnish Personal Identification Number". Country code "FI" must not be specified, if the specified "Identifier type" is other than "Business ID", "Finnish Personal Identification Number" or "Other identifier". If the "Identifier type" is set as "Finnish Personal Identification Number" or "Finnish Business ID", the country code can only be "FI".
Country name (CountryName)	irct:String70		V/ M	Mandatory data if "Country code" is "99".
Occupational accident insurance policy number (AcclnsPolicyNo)	irct:String20		M	



2.11 Reports data (Reports)

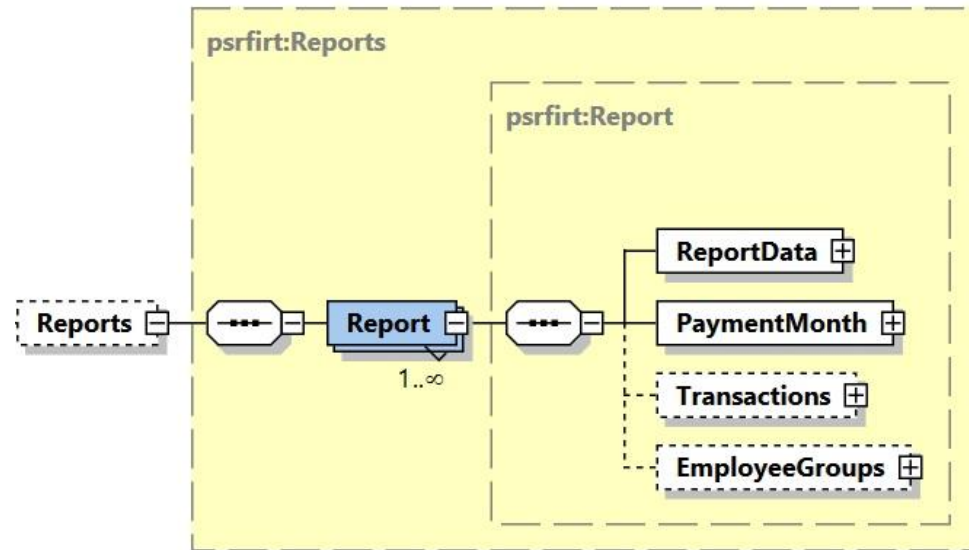

Data group details:

Data designation	Type	Allowed values	V/ M	Processing rule
Reports data (Reports)	psrtirt:Reports		M	
Report data (Report)	psrtirt:Report		M	There may be several reports.
Service data (ReportData)	psrtirt:ReportData		M	
Reporting period (PaymentMonth)	psrtirt:PaymentMonth		M	
Income types (Transactions)	psrtirt:Transactions		V/ M	
Employee groups (EmployeeGroups)	psrtirt:EmployeeGroups		V/ M	





2.12 Service data (ReportData)

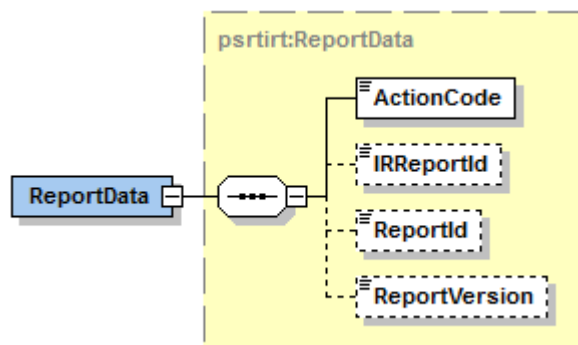

Data group details:

Data designation	Type	Allowed values	V/ M	Processing rule
Service data (ReportData)	psrtirt:ReportData		M	There may be only one instance of a report in a record (the same record may not contain both a new and a replacement report, or several replacement reports, of the same report).
Action type (ActionCode)	xs:int	Codes: ActionCode	M	
Incomes Register report reference (IRReportId)	irct:Guid		V/ M	Mandatory data if the "Action type" is "Replacement report" and "Payer's report reference" has not been specified. This data must not be specified if the "Action type" is "New report".
Payer's report reference (ReportId)	irct:String40		V/ M	Mandatory data in the following cases: <ul style="list-style-type: none"> "Action type" is "New report". "Action type" is "Replacement report" and the "Incomes Register report reference" data has not been specified. The payer's report reference must uniquely identify all employer's separate reports submitted by a specific payer (Payer).



Data designation	Type	Allowed values	V/ M	Processing rule
Report version number (ReportVersion)	xs:int		V	The version number must be a positive integer larger than zero. This data must not be specified if the "Action type" is "New report".



2.13 Reporting period (PaymentMonth)

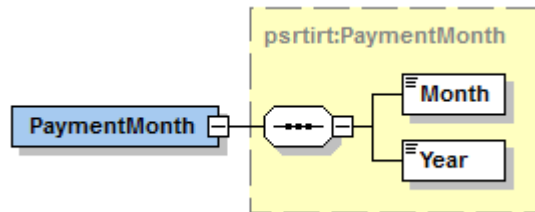

Data group details:

Data designation	Type	Allowed values	V/ M	Processing rule
Reporting period (PaymentMonth)	psrtirt:PaymentMonth		M	<p>If the only income type included in a report is "No wages payable" (101), the reporting period can be no longer than the current month + 6 months.</p> <p>If the report contains information other than "No salary" (101), the reporting period can be no longer than the current month + 1 month.</p> <p>If the "Action type" is "Replacement report", the data should match that of the report's previous version.</p>
Payment month (Month)	irct:MonthsType		M	
Payment year (Year)	xs:int		M	The payment year may be no earlier than 2019.



2.14 Income types (Transactions)

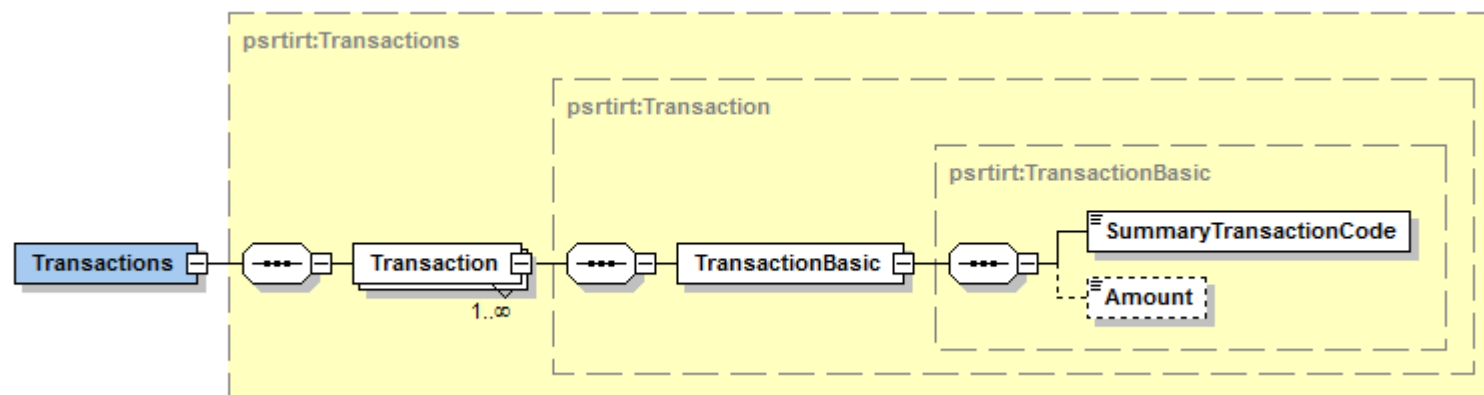

Data group details:

Data designation	Type	Allowed values	V/ M	Processing rule
Income types (Transactions)	psrtirt:Transactions		V/ M	Report must include at least either the Income types data group or the Employee groups data group. Both data groups may be given.
Income type data (Transactions)	psrtirt:Transaction		M	There may be several income types.
General details on the income type (TransactionBasic)	psrtirt:Transaction Basic		M	
Income type code (SummaryTransactionCode)	xs:int	Codes: SummaryTransaction Code	M	If income type 101 has been included in the report, income type 102 or 103 must not be included in the report.
Amount (Amount)	irct:decimal2		V/ M	Mandatory data, if the "Income type code" is not "101" (No wages payable).



2.15 Employee groups (EmployeeGroups)

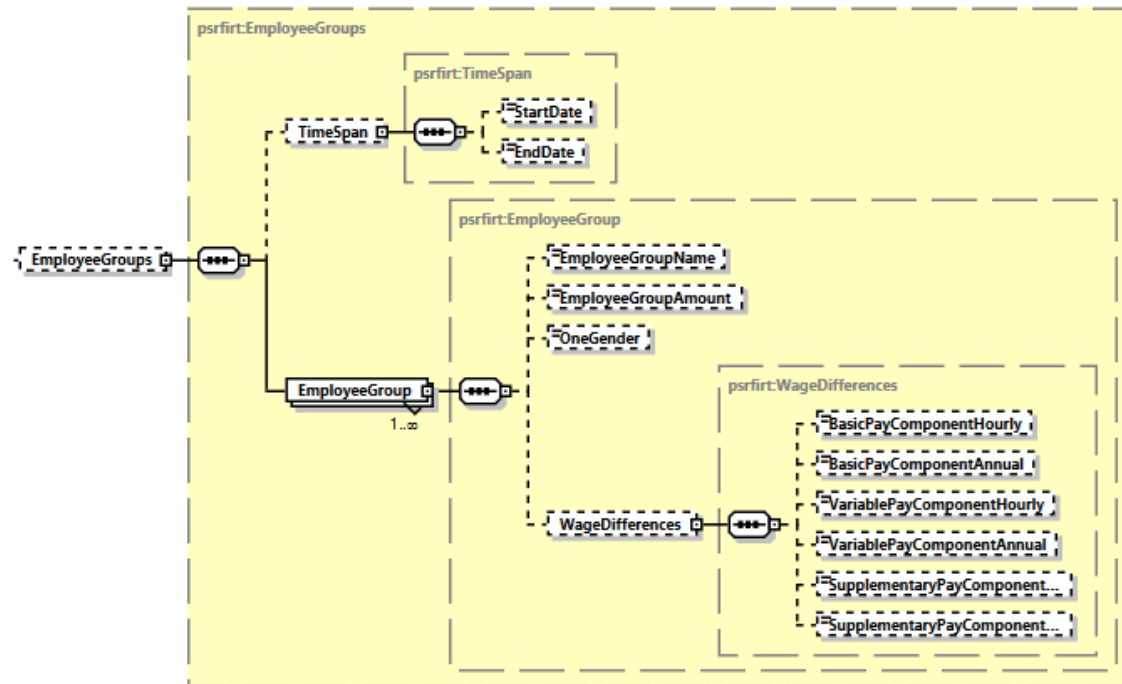

Data group details:

Data designation	Type	Allowed values	V/ M	Processing rule
Employee groups (EmployeeGroups)	psrirt:EmployeeGroups		V/ M	Report must include at least either the Income types data group or the Employee groups data group. Both data groups may be given.
Time range (TimeSpan)	psrirt:TimeSpan		M	
Start date (StartDate)	xs:date		M	The date must not be earlier than 1 January 2019.
End date (EndDate)	xs:date		M	The date must not be earlier than the Start date.
Employee group (EmployeeGroup)	psrirt:EmployeeGroup		M	There may be several employee groups.



Data designation	Type	Allowed values	V/ M	Processing rule
Employee group name (EmployeeGroupName)	irct:String100		V	
Employee group number of personnel (EmployeeGroupAmount)	xs:int		M	The value must be greater than 0.
Group has only one gender (OneGender)	irct:true	"true"	V/ M	The value must be "true", if the data group Pay gaps has not been given in the report. The data cannot be given if the data group Pay gaps has been given in the report.
Pay gaps (WageDifferences)	psrtirt:WageDifferences		V/ M	The data group is mandatory if the value "true" has not been given for the Group has only one gender (OneGender) data. The data cannot be given if the report has given the value "true" for the Group has only one gender data.
Basic wage component pay gap hourly pay (BasicPayComponentHourly)	xs:int		M	The value must be greater than or equal to 0, and smaller than 999,999,999.
Basic wage component pay gap annual pay (BasicPayComponentAnnual)	xs:int		M	The value must be greater than or equal to 0, and smaller than 999,999,999.
Adjusting wage component pay gap hourly pay (VariablePayComponentHourly) al)	xs:int		V	The value must be greater than or equal to 0, and smaller than 999,999,999.
Adjusting wage component pay gap annual pay (VariablePayComponentAnnual) al)	xs:int		V	The value must be greater than or equal to 0, and smaller than 999,999,999.



Data designation	Type	Allowed values	V/ M	Processing rule
Complementary wage component pay gap hourly pay (SupplementaryPayComponentHourly)	xs:int		V	The value must be greater than or equal to 0, and smaller than 999,999,999.
Complementary wage component pay gap annual pay (SupplementaryPayComponentAnnual)	xs:int		V	The value must be greater than or equal to 0, and smaller than 999,999,999.

