

Data delivery – Schemas – Benefits payment reports 2027

Incomes Register Unit

Version history

Version	Date	Description
1.0	27/10/2025	Published a version of the document containing the 2027 changes to data content. The changes apply when the payment date of the income is on 1 January 2027 or later.
		Added a new voluntary data group Reference data of the demand for rectification of personal data (DemandForRectificationIds) to the data group Service data (ReportData).
1.1	6/2/2026	The processing rule of Signature (Signature) has been updated: The element is not allowed with records submitted through the upload/download service.



CONTENTS

1	General	5
1.1	Schema.....	5
1.2	Character set.....	5
1.3	Dates and times.....	8
1.4	Document reading instructions.....	8
2	Benefits payment reports (BenefitReportsToIR)	9
2.1	Record data (DeliveryData).....	11
2.2	Contact persons for the record (ContactPersons)	16
2.3	Payer details (Payer)	17
2.4	Payer identifiers (PayerIds).....	18
2.5	Basic payer details (PayerBasic).....	20
2.6	Payer's address (Address).....	21
2.7	Payer's suborganisations (SubOrgs).....	23
2.8	Reports data (Reports).....	24
2.9	Service data (ReportData).....	25
2.10	Income earner details (IncomeEarner)	27
2.11	Income earner identifiers (IncomeEarnerIds).....	28
2.12	Basic income earner details (IncomeEarnerBasic).....	30
2.13	Income earner's address (Address).....	33
2.14	International situations (InternationalData).....	35
2.15	Income types (Transactions).....	36
2.16	General income type details (TransactionBasic).....	37
2.17	Earnings period (EarningPeriod)	40
2.18	Benefit unit (BenefitUnit).....	41
2.19	Additional income type details (TransactionOther).....	42
2.20	Additional repayment details (RecoveryData).....	43
2.21	Additional recourse details (RecourseData)	45
2.22	Insurance details (Insurance).....	46



2.23 Policyholder's identifiers (InsurancePolicyHolderIds).....	47
2.24 Basic policyholder details (InsurancePolicyHolderBasic)	49
2.25 Policyholder's address (Address)	51
2.26 Deductions (Deductions).....	53
2.27 Earnings period of original benefit (OrigBenefitEarningPeriod)	55
2.28 Substitute recipient details (IncomeBeneficiary).....	56
2.29 Substitute recipient identifiers (IncomeBeneficiaryIds)	57
2.30 Basic substitute recipient details (IncomeBeneficiaryBasic).....	59
2.31 Substitute recipient's address (Address).....	62
2.32 Period of calculation (RemittancePeriod)	64



1 GENERAL

1.1 Schema

Benefits payment reports are submitted to the Incomes Register using the **BenefitReportsToIR** schema.

The namespaces of the schema are the following:

File name	Prefix	Namespace
	xmlns:xs	http://www.w3.org/2001/XMLSchema
BenefitReportsToIR.xsd	xmlns:brtir	http://www.tulorekisteri.fi/2017/1/BenefitReportsToIR
BenefitReportsToIRTypes.xsd	xmlns:brtirt	http://www.tulorekisteri.fi/2017/1/BenefitReportsToIRTypes
IRCommonTypes.xsd	xmlns:irct	http://www.tulorekisteri.fi/2017/1/IRCommonTypes
xmldsig-core-schema.xsd	xmlns:ds	http://www.w3.org/2000/09/xmldsig#

Empty elements are not allowed in the messages. If an element receives no value, the element is left out of the message entirely. Empty character strings are also not allowed, i.e., the minimum length of all values is 1.

1.2 Character set

The schemas of the Incomes Register use UTF-8, which is the default character set of XML. The file must not contain the Byte Order Mark (BOM) character.

The following table presents the requirements for the conversion of special characters appearing in messages.

Character	Description	Presentation format as an entity
&	ampersand	& conversion is mandatory
<	less than	< conversion is mandatory
>	greater than	> conversion is not mandatory, but conforms with best practices
'	apostrophe	' conversion is not mandatory, but conforms with best practices
"	quotation mark	" conversion is not mandatory, but conforms with



		best practices
--	double hyphen	This character must not appear in an XML file
/*	slash asterisk	This character must not appear in an XML file
&#	ampersand hash	This character must not appear in an XML file

A limited character set is allowed for **reference data**. The allowed characters for the reference data listed below are the numbers 0-9, the letters a-z and A-Z and the symbols "_", "-" and ".".

- Record owner's record reference (DeliveryId)
- Payer's report reference (ReportId)
- Subscriber's primary subscription reference (MainSubscriptionId)
- Subscriber's secondary subscription reference (SubscriptionId)
- Sender's message reference (MessageId)
- Reference of the demand for rectification of personal data (DemandForRectificationId)

In the following data items, upper and lowercase characters are significant:

- Country codes in all data groups (for example, "DE" is interpreted to be a different code to "De").
- Customer identifiers in all data groups (for example, "150172-999H" is interpreted to be a different ID to "150172-999h").

The following table shows the non-printable whitespace characters that are not to be used in the Identifier (Code):

Unicode-merkki	Kuvaus	Esitysmuoto entiteettinä
U+0020	Välilyönti eli Space	 tai
U+0009	Sarkainmerkki eli Tabulator		 tai 	 tai &Tab
U+00A0	Sitova välilyönti eli yhdistävä välilyönti eli No-break Space	 tai tai &NonBreakingSpace
U+180E	Mongolian Vowel Separator	᠎ tai ᠎
U+2000	En Quad	  tai  
U+2001	Em Quad	  tai  



U+2002	Puolikas, En-Väli Eli En Space	  tai   tai &ensp
U+2003	Neliö, Em-Väli Eli Em Space	  tai   tai &emsp
U+2004	Three-Per-Em Space	  tai   tai &emsp13
U+2005	Neljännesväli eli Four-Per-Em Space	  tai   tai &emsp14
U+2006	Six-Per-Em Space	  tai  
U+2007	Figure Space	  tai   tai &numsp
U+2008	Punctuation Space	  tai   tai &puncsp
U+2009	Ohuke eli Thin Space	  tai   tai &ThinSpace
U+200A	Hieno väli eli Hair Space	  tai   tai &VeryThinSpace
U+200B	Leveydetön väli eli Zero Width Space	​ tai ​ tai &NegativeVeryThinSpace
U+202F	Kapea yhdistävä välilyönti tai kapea sitova välilyönti eli Narrow No-Break Space	  tai  
U+205F	Medium Mathematical Space	  tai   tai &MediumSpace
U+3000	Ideographic Space	　 tai 　
U+FEFF	Zero Width No-Break	﻿ tai ﻿
U+000A	Line Feed (Lf)	
 tai
 tai &NewLine
U+000B	Vertical Tabulation (Vt)	 tai
U+000C	Form Feed (Ff)	 tai 
U+000D	Carriage Return (Cr)	 tai 
U+0085	Next Line (Nel)	… tai …
U+2028	Line Separator (Ls)	  tai  
U+2029	Paragraph Separator (Ps)	  tai  



1.3 Dates and times

Dates (data type xs:date) must not include time zone information. Example of a date:

```
<StartDate>2017-05-11</StartDate>
```

Data elements containing times of day (data types xs:dateTime and xs:time) must include the time zone.

Example in the Finnish time zone (standard time, UTC+2):

```
<Timestamp>2017-05-11T08:00:00+02:00</Timestamp>
```

```
<Time>08:00:00+02:00</Time>
```

Example in UTC time (UTC+0):

```
<Timestamp>2017-05-11T6:00:00Z</Timestamp>
```

```
<Time>06:00:00Z</Time>
```

1.4 Document reading instructions

In the document diagrams, the 0 .. ∞ marking in the bottom right-hand corner of an element means that the element may appear several times or not at all. The 1 .. ∞ marking means that the element may appear several times, but it must always appear at least once. The mandatory elements are highlighted with a solid border line and voluntary elements with a dashed border line.

In the document tables, the mandatory or voluntary nature of the elements is depicted with the following markings:

V/M	Label
V	The element is always voluntary.
M	The element is mandatory if its "parent element" is included. Example: The "Payer's suborganisations (SubOrgs)" data group is voluntary (V), but if it is included, the "Payer's suborganisation (SubOrg)" (M) data group must be specified with data elements "Identifier type of benefit payer's suborganisation (Type)" (M) and "Suborganisation identifier (Code)" (M).
V/M	The element is conditionally mandatory. The data processing rules describe the situations in which the element is mandatory.

In some elements, messages use a limited range of values, i.e. codes. The possible values for these codes are described in the "Codes" and "Benefits – Codes – Income types" documents. This document refers to the values presented in the codesets using the term "codes".



2 BENEFITS PAYMENT REPORTS (BENEFITREPORTSTOIR)

The general structure of a record containing benefits payment reports submitted to the Incomes Register is as follows:

Data group name	Type	V/M
Record data (DeliveryData)	brtirt:DeliveryData	M
Contact persons for the record (ContactPersons)	brtirt:ContactPersons	M
Payer details (Payer)	brtirt:Payer	M
Payer identifiers (PayerIds)	brtirt:PayerIds	M
Basic payer details (PayerBasic)	brtirt:PayerBasic	V/M
Payer's address (Address)	brtirt:Address	V/M
Payer's suborganisations (SubOrgs)	brtirt:SubOrgs	V
Reports data (Reports)	brtirt:Reports	M
Report data (Report)	brtirt:Report	M
Service data (ReportData)	brtirt:ReportData	M
Income earner details (IncomeEarner)	brtirt:IncomeEarner	M
Income earner identifiers (IncomeEarnerIds)	brtirt:IncomeEarnerIds	V/M
Basic income earner details (IncomeEarnerBasic)	brtirt:IncomeEarnerBasic	V/M
Income earner's address (Address)	brtirt:Address	V/M
International situations (InternationalData)	brtirt:InternationalData	V
Income types (Transactions)	brtirt:Transactions	M
Income type details (Transaction)	brtirt:Transaction	M
General income type details (TransactionBasic)	brtirt:TransactionBasic	M
Earnings period (EarningPeriod)	brtirt:EarningPeriod	V/M
Benefit unit (BenefitUnit)	brtirt:BenefitUnit	V/M
Additional income type details (TransactionOther)	brtirt:TransactionOther	V/M
Additional repayment details (RecoveryData)	brtirt:RecoveryData	V/M



Data group name	Type	V/M
Additional recourse details (RecourseData)	brtirt:RecourseData	V/M
Insurance details (Insurance)	brtirt:Insurance	V/M
Policyholder details (InsurancePolicyHolder)	brtirt:InsurancePolicyHolder	M
Policyholder's identifiers (InsurancePolicyHolderIds)	brtirt:InsurancePolicyHolderIds	V/M
Basic policyholder details (InsurancePolicyHolderBasic)	brtirt:InsurancePolicyHolderBasic	V/M
Policyholder's address (Address)	brtirt:Address	V/M
Deductions (Deductions)	brtirt:Deductions	V
Deduction details (Deduction)	brtirt:Deduction	M
Earnings period of original benefit (OrigBenefitEarningPeriod)	brtirt:OrigBenefitEarningPeriod	M
Substitute recipient details (IncomeBeneficiary)	brtirt:IncomeBeneficiary	V
Substitute recipient identifiers (IncomeBeneficiaryIds)	brtirt:IncomeBeneficiaryIds	V/M
Basic substitute recipient details (IncomeBeneficiaryBasic)	brtirt:IncomeBeneficiaryBasic	M
Substitute recipient's address (Address)	brtirt:Address	V
Period of calculation (RemittancePeriod)	brtirt:RemittancePeriod	M
Signature (Signature)	xsig:SignatureType	V/M



2.1 Record data (DeliveryData)

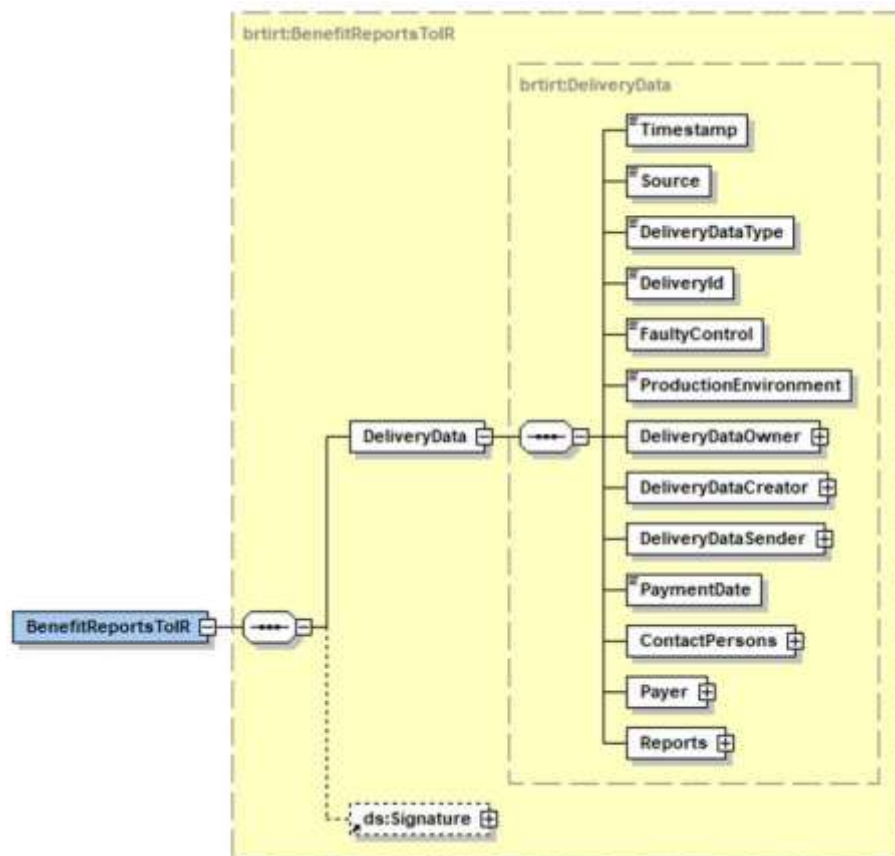

Data group details:

Data designation	Type	Allowed values	V/M	Processing rule
Record data (DeliveryData)	brtirt:DeliveryData		M	
Time of record creation (Timestamp)	xs:dateTime		M	
Data source (Source)	irct:String30		M	
Record type (DeliveryDataType)	xs:int	Codes: QueryDataType and value 102 from it	M	
Record owner's (payer's) record reference (DeliveryId)	irct:String40		M	The record owner's record reference must uniquely identify all records of a specific payer (Payer) containing benefits payment reports (DeliveryDataType=102).
Rule for processing invalid data (reports) (FaultyControl)	xs:int	Codes: FaultyControl	M	If the record contains invalid reports, this entry determines whether to reject only the invalid reports in the record or the entire record.
Production environment (ProductionEnvironment)	irct:trueOrFalse	Codes: ProductionEnvironm ent	M	If the value is "true", the data must have been delivered to the Incomes Register's production environment. If the value is "false", the data must have been delivered to the Incomes Register's test environment.
Record owner (DeliveryDataOwner)	brtirt:Id		M	Processing rules related to data items Record owner, Record creator and Record submitter: The payer has a customer identifier and the payer reports the data: At least one identifier has been specified in the data group Payer identifiers. The data item <i>Record owner</i> must be one of the payer identifiers. If a business ID has been specified in the data group Payer identifiers, it must be specified as the Record owner.



Data designation	Type	Allowed values	V/M	Processing rule
				<p>The Record owner (= payer) must be specified as the <i>Record creator</i>.</p> <p>The Record owner (= payer) must be specified as the <i>Record submitter</i>.</p> <p>The payer has a customer identifier and the service provider submits the data on behalf of the payer:</p> <p>At least one identifier has been specified in the data group Payer identifiers. The data item <i>Record owner</i> must be one of the payer identifiers. If a business ID has been specified in the data group Payer identifiers, it must be specified as the Record owner.</p> <p>The identifier of the service provider must be specified as the <i>Record creator</i>. If the service provider has a business ID, it must be specified. It must be specified in the Incomes Register that the service provider has the right to submit records on behalf of others.</p> <p>The Record creator (= service provider) must be specified as the <i>Record submitter</i>.</p>
Identifier type (Type)	xs:int	Codes: IdType	M	
Identifier (Code)	irct:String30		M	<p>If the "Identifier type" is "Business ID", the identifier must exist (according to information from the Business Information System (YTJ)).</p> <p>If the "Identifier type" is other than "Business ID" or "Finnish Personal Identification Number" identifier must not be Finnish personal identification number or Business ID.</p> <p>The data must not begin or end with non-printable whitespace characters, such as spaces. The data cannot contain non-printable whitespace characters, excluding space.</p>



Data designation	Type	Allowed values	V/M	Processing rule
Country code (CountryCode)	irct:String2	A two-character code in accordance with the ISO 3166 country codes. If the country is unknown, the value "99" is entered.	V/M	Mandatory data if "Identifier type" is other than "Business ID". Country code "FI" must not be specified, if the specified "Identifier type" is other than "Business ID", "Finnish Personal Identification Number" or "Other identifier". If the "Identifier type" is set as "Finnish Personal Identification Number" or "Finnish Business ID", the country code can only be "FI".
Country name (CountryName)	irct:String70		V/M	Mandatory data if "Country code" is "99".
Record creator (DeliveryDataCreator)	brtirt:Id		M	The processing rules for Identifier type, Identifier, Country code and Country name are the same as in the Record owner (DeliveryDataOwner) data group.
Record submitter (DeliveryDataSender)	brtirt:Id		M	The processing rules for Identifier type, Identifier, Country code and Country name are the same as in the Record owner (DeliveryDataOwner) data group.
Date of payment or other report (PaymentDate)	xs:date		M	The date must not be earlier than 1 January 2021 or more than 45 days later than the current date. If the "Action type" is "Replacement report", the data should match that of the report's previous version.
Contact persons for the record (ContactPersons)	brtirt:ContactPersons		M	
Payer details (Payer)	brtirt:Payer		M	
Reports data (Reports)	brtirt:Reports		M	
Signature (Signature)	xsig:SignatureType		V/M	The electronic signature of the record is delivered in this data group. The record must be signed using the certificate of the party specified as the Record creator.



Data designation	Type	Allowed values	V/M	Processing rule
				The element is not allowed with records submitted through the upload/download service.



2.2 Contact persons for the record (ContactPersons)

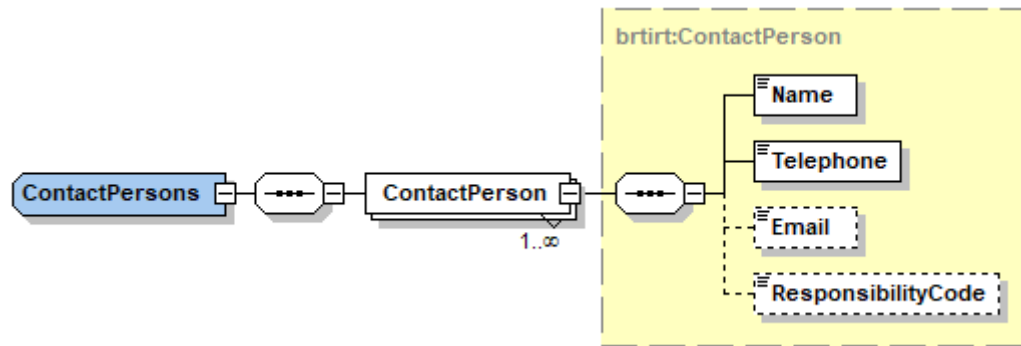

Data group details:

Data designation	Type	Allowed values	V/M	Processing rule
Contact persons for the record (ContactPersons)	brtirt:ContactPersons		M	
Contact person for the record (ContactPerson)	brtirt:ContactPerson		M	There may be several contact persons.
Name (Name)	irct:String200		M	
Telephone number (Telephone)	irct:String40		M	
E-mail address (Email)	irct:String70		V	
Field of responsibility (ResponsibilityCode)	xs:int	Codes: ResponsibilityCode	V	



2.3 Payer details (Payer)

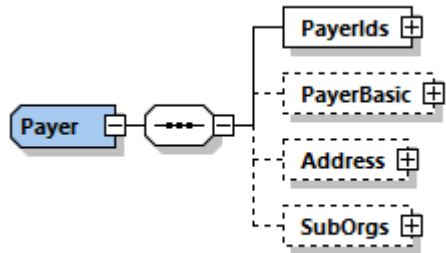

Data group details:

Data designation	Type	V/M
Payer details (Payer)	brtirt:Payer	M
Payer identifiers (PayerIds)	brtirt:PayerIds	M
Basic payer details (PayerBasic)	brtirt:PayerBasic	V/M
Payer's address (Address)	brtirt:Address	V/M
Payer's suborganisations (SubOrgs)	brtirt:SubOrgs	V



2.4 Payer identifiers (PayerIds)

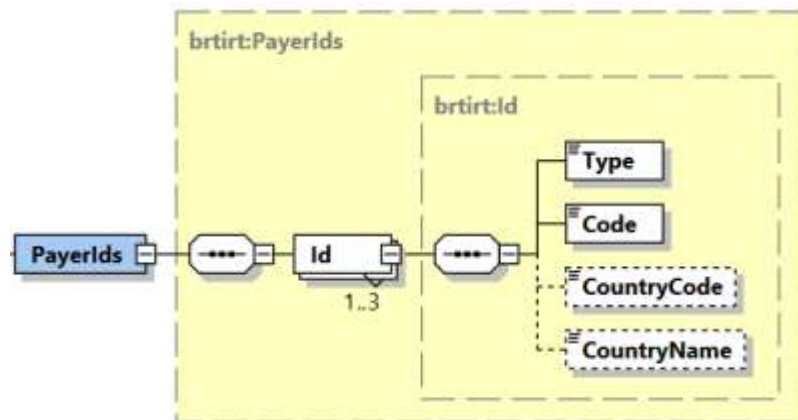

Data group details:

Data designation	Type	Allowed values	V/M	Processing rule
Payer identifiers (PayerIds)	brtirt:PayerIds		M	<p>If the "Action type" is "Replacement report", the data should match that of the report's previous version.</p> <p>If multiple identifiers have been given in the data group, the identifier types cannot be the same. The same combination of identifier type and country code cannot be entered multiple times. There can only be one identifier type of "Finnish Personal Identification Number" or "Finnish Business ID" in the data group.</p>
Payer's identifier (Id)	brtirt:Id		M	<p>A payer can be given up to three payer identifiers.</p> <p>The payer's and the income earner's identifiers may not be the same (none of the payer's identifiers may be the same as any of the income earner's identifiers).</p>



Data designation	Type	Allowed values	V/M	Processing rule
Benefit payer's identifier type (Type)	xs:int	Codes: BenefitPayerIdType	M	
Identifier (Code)	irct:String30		M	<p>If the "Benefit payer's identifier type" is "Business ID", the identifier must exist (according to information from the Business Information System (YTJ)).</p> <p>If the "Identifier type" is other than "Business ID" or "Finnish Personal Identification Number" identifier must not be Finnish personal identification number or Business ID.</p> <p>The data must not begin or end with non-printable whitespace characters, such as spaces. The data cannot contain non-printable whitespace characters, excluding space.</p>
Country code (CountryCode)	irct:String2	A two-character code in accordance with the ISO 3166 country codes. If the country is unknown, the value "99" is entered.	V/M	<p>Mandatory data if "Benefit payer's identifier type" is other than "Business ID".</p> <p>Country code "FI" must not be specified, if the specified "Identifier type" is other than "Business ID", "Finnish Personal Identification Number" or "Other identifier".</p> <p>If the "Identifier type" is set as "Finnish Personal Identification Number" or "Finnish Business ID", the country code can only be "FI".</p>
Country name (CountryName)	irct:String70		V/M	Mandatory data if "Country code" is "99".



2.5 Basic payer details (PayerBasic)



Data group details:

Data designation	Type	Allowed values	V/M	Processing rule
Basic payer details (PayerBasic)	brtirt:PayerBasic		V/M	Mandatory data group if no identifiers where "Benefit payer's identifier type" is "Business ID" have been specified in the "Payer identifiers" data group.
Company name (CompanyName)	irct:String200		M	



2.6 Payer's address (Address)

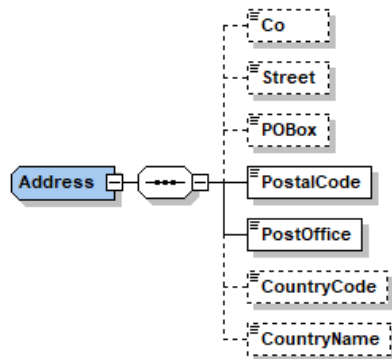

Data group details:

Data designation	Type	Allowed values	V/M	Processing rule
Payer's address (Address)	brtirt:Address		V/M	Mandatory data group if no identifiers where "Benefit payer's identifier type" is "Business ID" have been specified in the "Payer identifiers" data group.
c/o (Co)	irct:String70		V	
Street address (Street)	irct:String100		V/M	If this data group is included, either "Street address" or "P.O. Box" must be specified. Both must not be entered.
P.O. Box (POBox)	irct:String10		V/M	If this data group is included, either "Street address" or "P.O. Box" must be specified. Both must not be entered.
Postal code (PostalCode)	irct:String20		M	
City (PostOffice)	irct:String200		M	
Country code (CountryCode)	irct:String2	A two-character code in accordance with the ISO 3166 country codes.	V/M	Mandatory data group if no identifiers where "Benefit payer's identifier type" is "Business ID" have been specified in the "Payer identifiers" data group.



Data designation	Type	Allowed values	V/M	Processing rule
		If the country is unknown, the value "99" is entered.		
Country name (CountryName)	irct:String70		V/M	Mandatory data if "Country code" is "99".



2.7 Payer's suborganisations (SubOrgs)

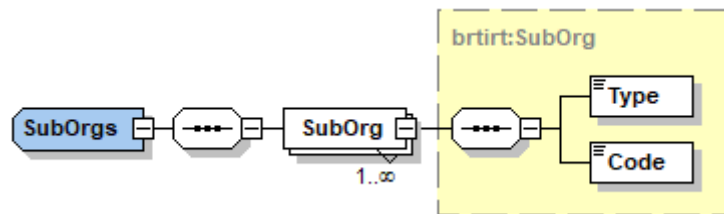

Data group details:

Data designation	Type	Allowed values	V/M	Processing rule
Payer's suborganisations (SubOrgs)	brtirt:SubOrgs		V	
Payer's suborganisation (SubOrg)	brtirt:SubOrg		M	A payer can have several suborganisations (however, only one identifier type of benefit payer's suborganisation is identified in the codeset thus far). A payer can have only one suborganisation, conforming to the "Identifier type of benefit payer's suborganisation" data item.
Identifier type of benefit payer's suborganisation (Type)	xs:int	Codes: BenefitPayerSubOrg Type	M	
Suborganisation identifier (Code)	irct:String20		M	



2.8 Reports data (Reports)

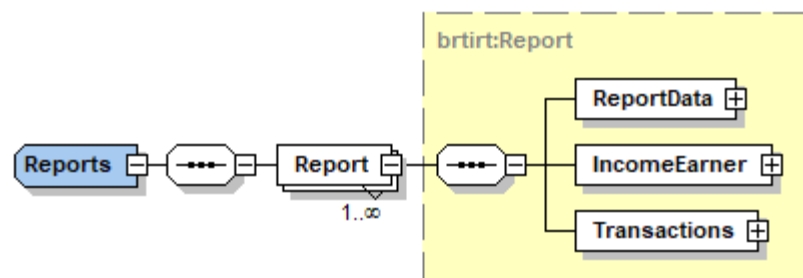

Data group details:

Data designation	Type	V/M
Reports data (Reports)	brtirt:Reports	M
Report data (Report)	brtirt:Report	M
Service data (ReportData)	brtirt:ReportData	M
Income earner details (IncomeEarner)	brtirt:IncomeEarner	M
Income types (Transactions)	brtirt:Transactions	M



2.9 Service data (ReportData)

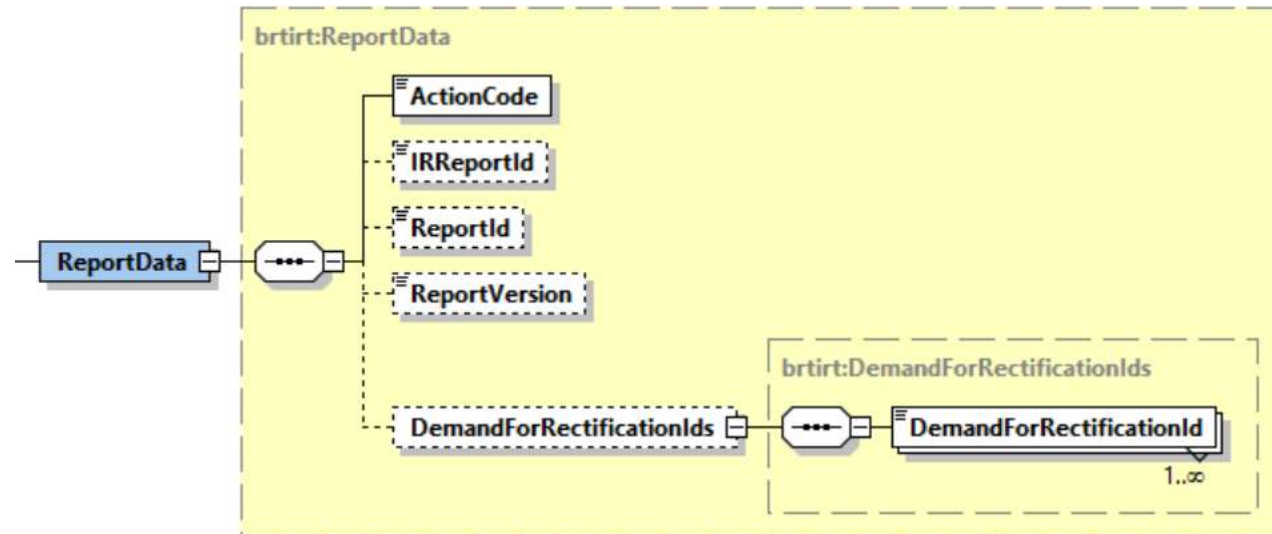

Data group details:

Data designation	Type	Allowed values	V/M	Processing rule
Service data (ReportData)	<code>brtirt:ReportData</code>		M	There may be only one instance of a report in a record (the same record may not contain both a new and a replacement report, or several replacement reports, of the same report).
Action type (ActionCode)	<code>xs:int</code>	Codes: ActionCode	M	
Incomes Register report reference (IRReportId)	<code>irct:Guid</code>		V/M	Mandatory data if the "Action type" is "Replacement report" and "Payer's report reference" has not been specified. This data must not be specified if the "Action type" is "New report".
Payer's report reference (ReportId)	<code>irct:String40</code>		V/M	Mandatory data in the following cases:



Data designation	Type	Allowed values	V/M	Processing rule
				<ul style="list-style-type: none"> "Action type" is "New report". "Action type" is "Replacement report" and the "Incomes Register report reference" data has not been specified. <p>The payer's report reference must uniquely identify all benefits payment reports of a specific payer (Payer).</p>
Report version number (ReportVersion)	xs:int		V	<p>The version number must be a positive integer larger than zero.</p> <p>This data must not be specified if the "Action type" is "New report".</p>
Reference data of the demand for rectification of personal data (DemandForRectificationIds)	brtirt:DemandForRectificationIds		V	
Reference of the demand for rectification of personal data (DemandForRectificationId)	irct:String40		M	<p>The report can have multiple "Reference of the demand for rectification of personal data". If a Reference of the demand for rectification of personal data is provided, there must be a corresponding demand for rectification of personal data sent by the Incomes Register authority. The same Reference of the demand for rectification of personal data may appear in the record only once.</p>



2.10 Income earner details (IncomeEarner)

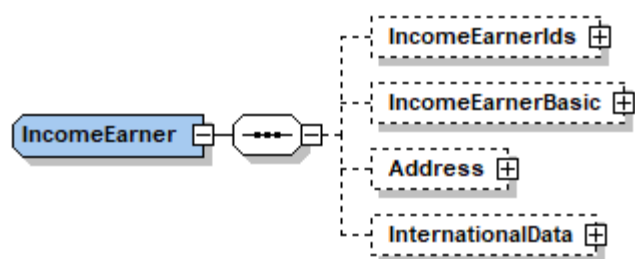

Data group details:

Data designation	Type	V/M
Income earner details (IncomeEarner)	brtirt:IncomeEarner	M
Income earner identifiers (IncomeEarnerIds)	brtirt:IncomeEarnerIds	V/M
Basic income earner details (IncomeEarnerBasic)	brtirt:IncomeEarnerBasic	V/M
Income earner's address (Address)	brtirt:Address	V/M
International situations (InternationalData)	brtirt:InternationalData	V



2.11 Income earner identifiers (IncomeEarnerIds)

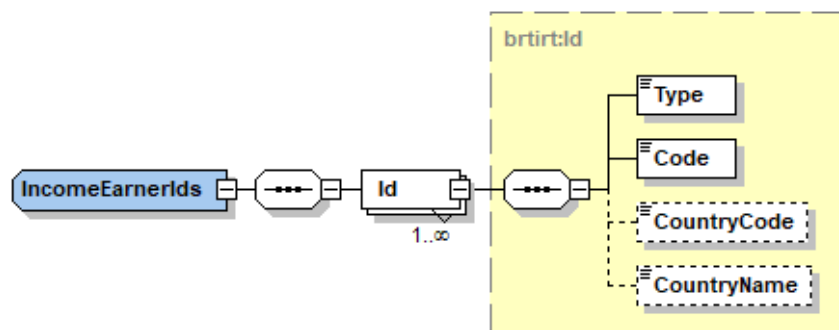

Data group details:

Data designation	Type	Allowed values	V/M	Processing rule
Income earner identifiers (IncomeEarnerIds)	brtirt:IncomeEarnerIds		V/M	<p>Mandatory data group, if "The income earner does not have a customer identifier" has not been specified. The data group must not be included, if "The income earner does not have a customer identifier" has been specified. If the "Action type" is "Replacement report", the data should match that of the report's previous version.</p> <p>If multiple identifiers have been given in the data group, the identifier types cannot be the same. The same combination of identifier type and country code cannot be entered multiple times. There can only be one identifier type of "Finnish Personal Identification Number" or "Finnish Business ID" in the data group.</p>
Income earner identifier (Id)	brtirt:Id		M	An income earner can have several identifiers.



Data designation	Type	Allowed values	V/M	Processing rule
				If the income earner is given both a Business ID and a Finnish Personal Identification Number, the identifiers must refer to the same customer.
Benefit recipient's identifier type (Type)	xs:int	Codes: BenefitIncomeEarner IdType	M	
Identifier (Code)	irct:String30		M	<p>If the "Benefit recipient's identifier type" is "Business ID", the identifier must exist (according to information from the Business Information System (YTJ)).</p> <p>If the "Benefit recipient's identifier type" is "Finnish Personal Identification Number", the identifier must exist (according to information from the Population Information System (VTJ)).</p> <p>If the "Identifier type" is other than "Business ID" or "Finnish Personal Identification Number" identifier must not be Finnish personal identification number or Business ID.</p> <p>The data must not begin or end with non-printable whitespace characters, such as spaces. The data cannot contain non-printable whitespace characters, excluding space.</p>
Country code (CountryCode)	irct:String2	A two-character code in accordance with the ISO 3166 country codes. If the country is unknown, the value "99" is entered.	V/M	<p>Mandatory data if "Benefit recipient's identifier type" is other than "Business ID" or "Finnish Personal Identification Number".</p> <p>Country code "FI" must not be specified, if the specified "Identifier type" is other than "Business ID", "Finnish Personal Identification Number" or "Other identifier".</p> <p>If the "Identifier type" is set as "Finnish Personal Identification Number" or "Finnish Business ID", the country code can only be "FI".</p>
Country name (CountryName)	irct:String70		V/M	Mandatory data if "Country code" is "99".



2.12 Basic income earner details (IncomeEarnerBasic)

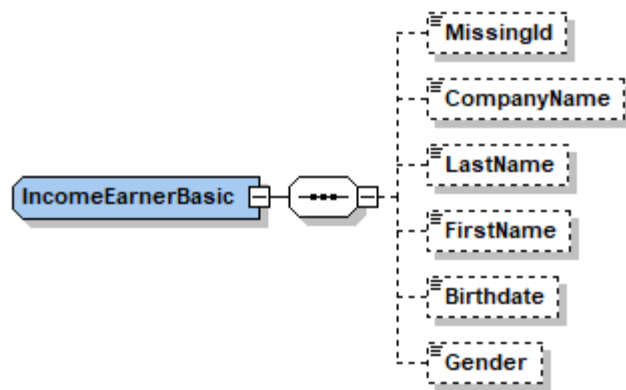

Data group details:

Data designation	Type	Allowed values	V/M	Processing rule
Basic income earner details (IncomeEarnerBasic)	brtirt:IncomeEarnerBasic		V/M	Mandatory data group if no identifiers where "Benefit recipient's identifier type" is "Business ID" or "Finnish Personal Identification Number" have been specified in the "Income earner identifiers" data group.
The income earner does not have a customer identifier (MissingId)	irct:true	"true"	V/M	Mandatory data if no identifiers have been specified for the income earner in the "Income earner identifiers" data group. This data must not be submitted if identifiers have been specified for the income earner in the "Income earner identifiers" data group.
Company name (CompanyName)	irct:String200		V/M	Mandatory data in the following cases: <ul style="list-style-type: none"> No identifier where the "Benefit recipient's identifier type" is "Business ID" or "Finnish Personal Identification Number" has been specified in the "Income earner identifiers" data group, and "Last name" and "First name" have not been specified.



Data designation	Type	Allowed values	V/M	Processing rule
				<ul style="list-style-type: none"> The value of "The income earner does not have a customer identifier" is "true", and "Last name" and "First name" have not been specified. <p>This data must not be specified if "Last name" and "First name" have been specified.</p>
Last name (LastName)	irct:String200		V/M	<p>Mandatory data in the following cases:</p> <ul style="list-style-type: none"> No identifier where the "Benefit recipient's identifier type" is "Business ID" or "Finnish Personal Identification Number" has been specified in the "Income earner identifiers" data group, and "Company name" has not been specified. The value of "The income earner does not have a customer identifier" is "true", and "Company name" has not been specified. <p>This data must not be specified if "Company name" has been specified.</p>
First name (FirstName)	irct:String100		V/M	Checked in the same way as "Last name".
Date of birth (BirthDate)	xs:date		V/M	<p>Mandatory data in the following cases:</p> <ul style="list-style-type: none"> No identifier where the "Benefit recipient's identifier type" is "Finnish Personal Identification Number" has been specified in the "Income earner identifiers" data group, and "Last name" and "First name" have been specified. The value of "The income earner does not have a customer identifier" is "true", and "First name" and "Last name" have been specified. <p>The date must not be later than the current date.</p>



Data designation	Type	Allowed values	V/M	Processing rule
				<p>The date may not be earlier than 1 January 1800.</p> <p>If the "Action type" is "Replacement report", the data should match that of the report's previous version.</p>
Gender (Gender)	xs:int	Codes: Gender	V/M	Mandatory data if no identifier where the "Benefit recipient's identifier type" is "Finnish Personal Identification Number" has been specified in the "Income earner identifiers" data group, and "Last name" and "First name" have been specified.



2.13 Income earner's address (Address)

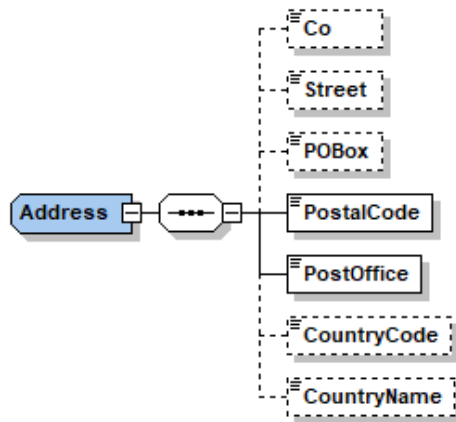

Data group details:

Data designation	Type	Allowed values	V/M	Processing rule
Income earner's address (Address)	brtirt:Address		V/M	Mandatory data group in the following cases: <ul style="list-style-type: none"> No identifiers where "Benefit recipient's identifier type" is "Business ID" or "Finnish Personal Identification Number" have been specified in the "Income earner identifiers" data group. The value of "The income earner does not have a customer identifier" is "true". The value of "Non-resident taxpayer" is "true".
c/o (Co)	irct:String70		V	
Street address (Street)	irct:String100		V/M	If this data group is included, either "Street address" or "P.O. Box" must be specified. Both must not be entered.
P.O. Box (POBox)	irct:String10		V/M	If this data group is included, either "Street address" or "P.O. Box" must be specified. Both must not be entered.
Postal code (PostalCode)	irct:String20		M	



Data designation	Type	Allowed values	V/M	Processing rule
City (PostOffice)	irct:String200		M	
Country code (CountryCode)	irct:String2	A two-character code in accordance with the ISO 3166 country codes. If the country is unknown, the value "99" is entered.	V/M	Mandatory data in the following cases: <ul style="list-style-type: none"> No identifier where "Benefit recipient's identifier type" is "Business ID" or "Finnish Personal Identification Number" has been specified in the "Income earner identifiers" data group. The value of "The income earner does not have a customer identifier" is "true". The value of "Non-resident taxpayer" is "true".
Country name (CountryName)	irct:String70		V/M	Mandatory data if "Country code" is "99".



2.14 International situations (InternationalData)

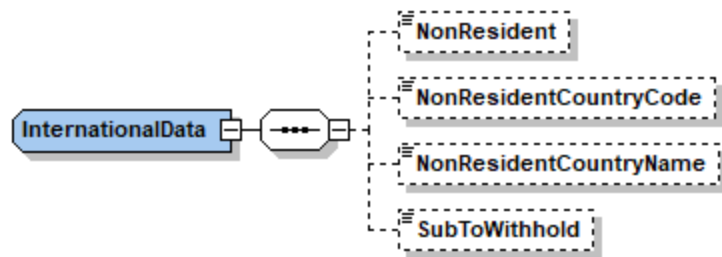

Data group details:

Data designation	Type	Allowed values	V/M	Processing rule
International situations (InternationalData)	brtirt:InternationalData		V	
Non-resident taxpayer (NonResident)	irct:true	"true"	V	
Country code of country of residence (NonResidentCountryCode)	irct:String2	A two-character code in accordance with the ISO 3166 country codes. If the country is unknown, the value "99" is entered.	V/M	Mandatory data, if "Non-resident taxpayer" is "true".
Name of country of residence (NonResidentCountryName)	irct:String70		V/M	Mandatory data if "Country code" is "99".
Income subject to withholding (SubToWithhold)	irct:true	"true"	V	This data can be specified only if the value of "Non-resident taxpayer" is "true".



2.15 Income types (Transactions)

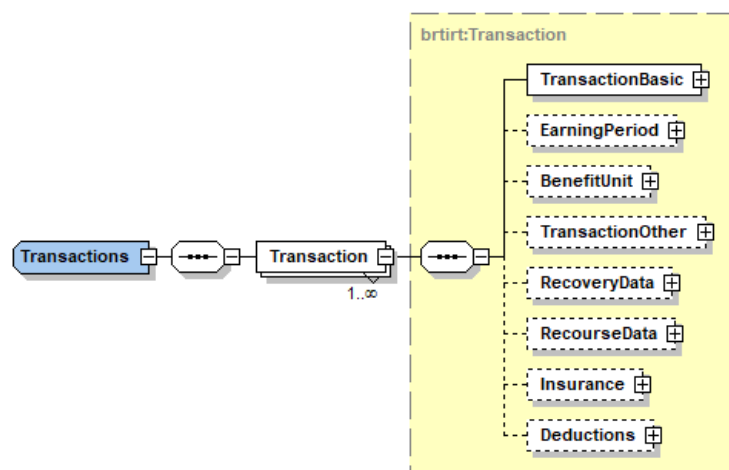

Data group details:

Data designation	Type	V/M	
Income types (Transactions)	brtirt:Transactions	M	
Income type details (Transactions)	brtirt:Transaction	M	An income earner can have several income types.
General income type details (TransactionBasic)	brtirt:TransactionBasic	M	
Earnings period (EarningPeriod)	brtirt:EarningPeriod	V/M	
Benefit unit (BenefitUnit)	brtirt:BenefitUnit	V/M	
Additional income type details (TransactionOther)	brtirt:TransactionOther	V/M	
Additional repayment details (RecoveryData)	brtirt:RecoveryData	V/M	
Additional recourse details (RecourseData)	brtirt:RecourseData	V	
Insurance details (Insurance)	brtirt:Insurance	V/M	
Deductions (Deductions)	brtirt:Deductions	V	



2.16 General income type details (TransactionBasic)

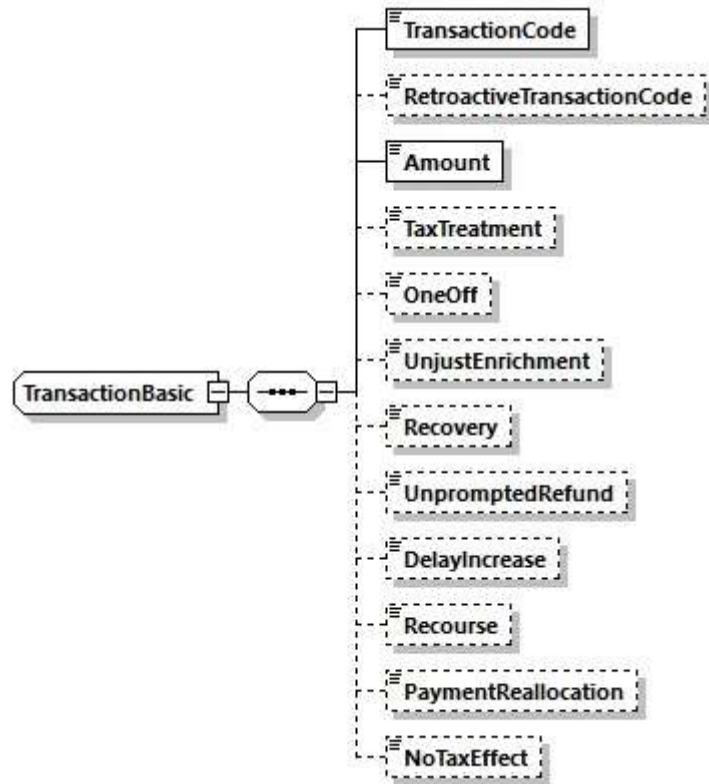

Data group details:

Data designation	Type	Allowed values	V/M	Processing rule
General income type details (TransactionBasic)	brtirt:TransactionBasic		M	Only one of the following data items can be specified for an income type: "Unjust enrichment", "Recovery", "Recourse" and "Unprompted refund".

Data designation	Type	Allowed values	V/M	Processing rule
				If, for example, the data item "Unjust enrichment" = "true" has been specified for an income type, the data items "Recovery" = "true", "Recourse" = "true" or "Unprompted refund" = "true" cannot be specified for the income type at the same time.
Income type code (TransactionCode)	xs:int	Codes: BenefitTransactionCode	M	
Income type changed, new income type code (RetroactiveTransactionCode)	xs:int	Codes: BenefitTransactionCode	V	
Amount (Amount)	irct:decimal2		M	The "Benefits – Codes – Income types" document lists the income types ("Income type code") for which a negative "Amount" can be specified. A negative "Amount" must not be specified for other income types. If any of the income types on the report have "Recovery" or "UnpromptedRefund" set as "true", a negative value for "Amount" cannot be entered.
Taxability of benefit (TaxTreatment)	xs:int	Codes: BenefitTaxTreatment	V/M	The "Benefits – Codes – Income types" document lists the income types ("Income type code") for which this data is mandatory. The "Benefits – Codes – Income types" document lists the income types ("Income type code") for which this data must not be specified.
One-off remuneration (OneOff)	irct:true	"true"	V	
Unjust enrichment (UnjustEnrichment)	irct:true	"true"	V	The "Benefits – Codes – Income types" document lists the income types ("Income type code") for which this data must not be specified.



Data designation	Type	Allowed values	V/M	Processing rule
Recovery (Recovery)	irct:true	"true"	V	<p>If the "Action type" is "Replacement report", the data should match that of the report's previous version.</p> <p>The "Benefits – Codes – Income types" document lists the income types ("Income type code") for which this data must not be specified.</p>
Unprompted refund (UnpromptedRefund)	irct:true	"true"	V	If the "Action type" is "Replacement report", the data should match that of the report's previous version.
Late payment increase (DelayIncrease)	irct:true	"true"	V	If the "Action type" is "Replacement report", the data should match that of the report's previous version.
Recourse (Recourse)	irct:true	"true"	V	
Payment reallocation (PaymentReallocation)	irct:true	"true"	V	
No effect on taxation (NoTaxEffect)	irct:true	"true"	V	



2.17 Earnings period (EarningPeriod)

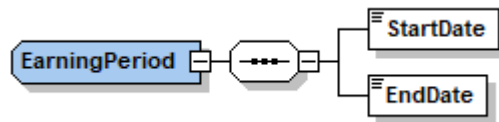

Data group details:

Data designation	Type	Allowed values	V/M	Processing rule
Earnings period (EarningPeriod)	brtirt:EarningPeriod		V/M	The data group is mandatory if "Recovery" is not "true" and "Unprompted refund" is not "true". The data group may not be entered if "Recovery" is "true" or if "Unprompted refund" is "true".
Start date (StartDate)	xs:date		M	The date may not be earlier than 1 January 1800.
End date (EndDate)	xs:date		M	The date must not be earlier than the "Start date".



2.18 Benefit unit (BenefitUnit)

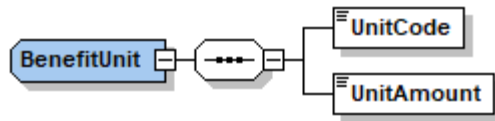

Data group details:

Data designation	Type	Allowed values	V/M	Processing rule
Benefit unit (BenefitUnit)	brtirt:BenefitUnit		V/M	The "Benefits – Codes – Income types" document lists the income types ("Income type code") for which this data group is mandatory.
Unit (UnitCode)	xs:int	Codes: BenefitUnitCode	M	
Number of units (UnitAmount)	irct:decimal2		M	The value must be non-negative.



2.19 Additional income type details (TransactionOther)

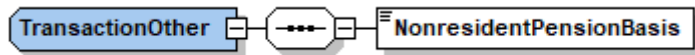

Data group details:

Data designation	Type	Allowed values	V/M	Processing rule
Additional income type details (TransactionOther)	brtirt:TransactionOther		V/M	
Grounds for pension paid to a non-resident taxpayer (NonresidentPensionBasis)	xs:int	Codes: NonresidentPensionBasis	M	<p>This data is mandatory if "Non-resident taxpayer" is "true" and the income type ("Income type code") is specified in the "Benefits – Codes – Income types" document as one for which this data is mandatory for non-resident taxpayers.</p> <p>This data can be specified only if "Non-resident taxpayer" is "true", and</p> <ul style="list-style-type: none"> the income type ("Income type code") is specified in the "Benefits – Codes – Income types" document as one for which this data is mandatory for non-resident taxpayers, or the income type ("Income type code") is "Withholding".



2.20 Additional repayment details (RecoveryData)

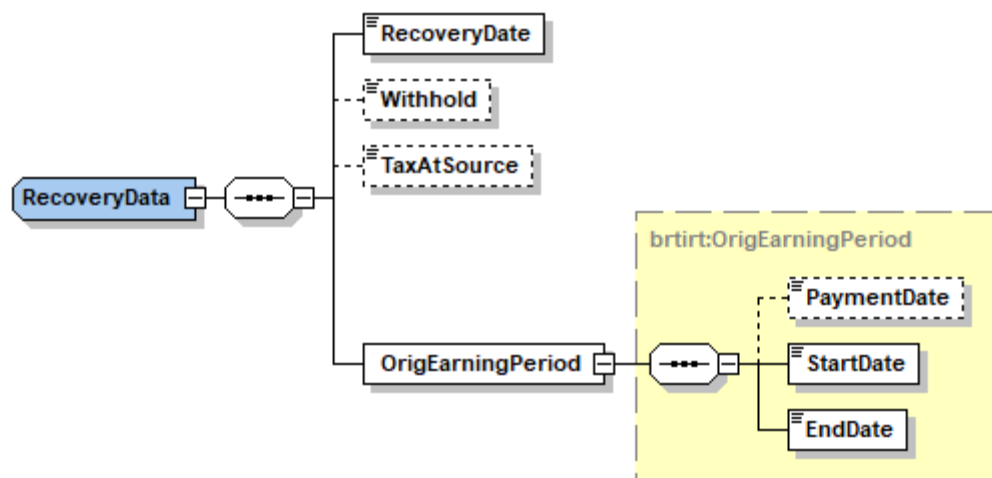

Data group details:

Data designation	Type	Allowed values	V/M	Processing rule
Additional repayment details (RecoveryData)	brtirt:RecoveryData		V/M	The data group is mandatory if "Recovery" is "true" or if "Unprompted refund" is "true". The data group may not be entered if "Recovery" is not "true" and "Unprompted refund" is not "true".
Repayment date (RecoveryDate)	xs:date		M	The date must not be earlier than 1 January 2021. The entered date must not be later than the date entered for "Date of payment or other report (PaymentDate)" in data group "Record data (DeliveryData)".
Withholding from the repayment (Withhold)	irct:decimal2		V	
Tax at source from the repayment (TaxAtSource)	irct:decimal2		V	



Data designation	Type	Allowed values	V/M	Processing rule
Original payment period (OrigEarningPeriod)	brtirt:OrigEarningPeriod		M	<p>"Start date" and "End date" must be within the same calendar year.</p> <p>If the "Action type" is "Replacement report", the data should match that of the report's previous version.</p> <p>The income type code for a recovery or unprompted refund must be valid partially or completely during the original payment period or date of payment.</p>
Date of payment or other report (PaymentDate)	xs:date		V	The date must not be earlier than 1 January 1800. The date entered must not be later than the date for "Repayment date (RecoveryDate)".
Start date (StartDate)	xs:date		M	The date may not be earlier than 1 January 1800.
End date (EndDate)	xs:date		M	The "End date" may not be earlier than the "Start date".



2.21 Additional recourse details (RecourseData)

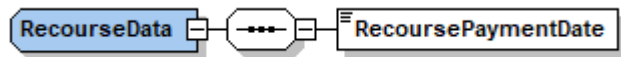

Data group details:

Data designation	Type	Allowed values	V/M	Processing rule
Additional recourse details (RecourseData)	brtirt:RecourseData		V	The data can be specified only if the value of "Recourse" is "true".
Recourse from tax-exempt income, payment date (RecoursePaymentDate)	xs:date		M	"Recourse from tax-exempt income, payment date" must not be earlier than the "Date of payment or other report". The date may not be earlier than 1 January 1800.



2.22 Insurance details (Insurance)

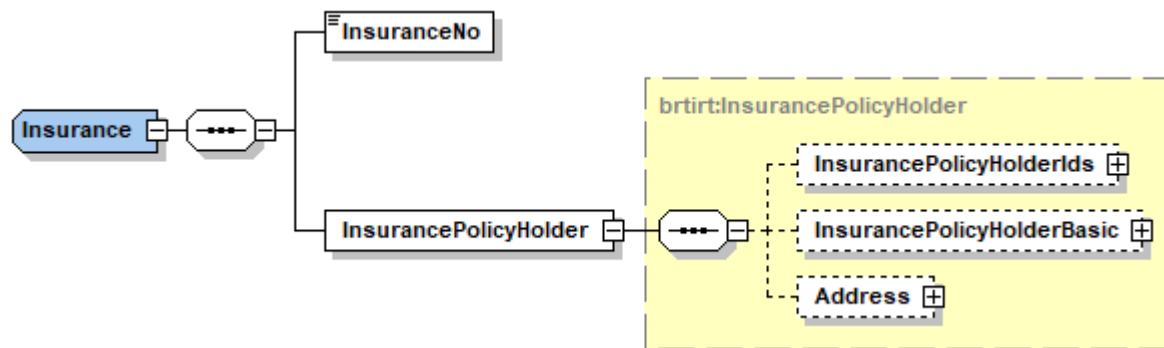

Data group details:

Data designation	Type	Allowed values	V/M	Processing rule
Insurance details (Insurance)	brtirt:Insurance		V/M	Mandatory data group if the value of "Taxability of benefit" is "Tax-exempt, data according to the act on inheritance and gift tax is given" or "Capital income, and data according to the act on inheritance and gift tax is given".
Policy number or other identifier (InsuranceNo)	irct:String20		M	
Policyholder details (InsurancePolicyHolder)	brtirt:InsurancePolicyHolder		M	
Policyholder's identifiers (InsurancePolicyHolderIds)	brtirt:InsurancePolicyHolderIds		V/M	
Basic policyholder details (InsurancePolicyHolderBasic)	brtirt:InsurancePolicyHolderBasic		V/M	
Policyholder's address (Address)	brtirt:Address		V/M	



2.23 Policyholder's identifiers (InsurancePolicyHolderIds)

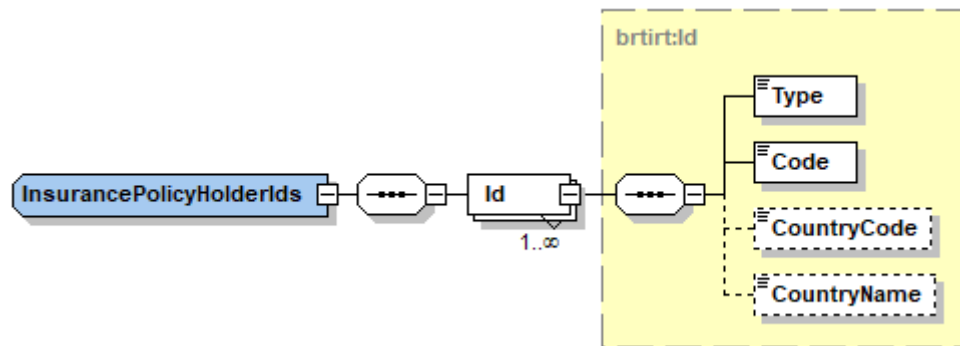

Data group details:

Data designation	Type	Allowed values	V/M	Processing rule
Policyholder's identifiers (InsurancePolicyHolderIds)	brtirt:InsurancePolicyHolderIds		V/M	<p>Mandatory data group if "The policyholder does not have a customer identifier" has not been specified.</p> <p>The data group must not be included if "The policyholder does not have a customer identifier" has been specified.</p> <p>If multiple identifiers have been given in the data group, the identifier types cannot be the same. The same combination of identifier type and country code cannot be entered multiple times. There can only be one identifier type of "Finnish Personal Identification Number" or "Finnish Business ID" in the data group.</p>
Policyholder's identifier (Id)	brtirt:Id		M	<p>A policyholder can have several identifiers.</p> <p>If the policyholder is given both a Business ID and a Finnish Personal Identification Number, the identifiers must refer to the same customer.</p>
Identifier type (Type)	xs:int	Codes: IdType	M	



Data designation	Type	Allowed values	V/M	Processing rule
Identifier (Code)	irct:String30		M	<p>If the "Identifier type" is "Finnish Personal Identification Number", the identifier must exist (according to information from the Population Information System (VTJ)).</p> <p>If the "Identifier type" is "Business ID", the identifier must exist (according to information from the Business Information System (YTJ)).</p> <p>If the "Identifier type" is other than "Business ID" or "Finnish Personal Identification Number" identifier must not be Finnish personal identification number or Business ID.</p> <p>The data must not begin or end with non-printable whitespace characters, such as spaces. The data cannot contain non-printable whitespace characters, excluding space.</p>
Country code (CountryCode)	irct:String2	<p>A two-character code in accordance with the ISO 3166 country codes.</p> <p>If the country is unknown, the value "99" is entered.</p>	V/M	<p>Mandatory data if "Identifier type" is other than "Business ID" or "Finnish Personal Identification Number".</p> <p>Country code "FI" must not be specified, if the specified "Identifier type" is other than "Business ID", "Finnish Personal Identification Number" or "Other identifier".</p> <p>If the "Identifier type" is set as "Finnish Personal Identification Number" or "Finnish Business ID", the country code can only be "FI".</p>
Country name (CountryName)	irct:String70		V/M	Mandatory data if "Country code" is "99".



2.24 Basic policyholder details (InsurancePolicyHolderBasic)

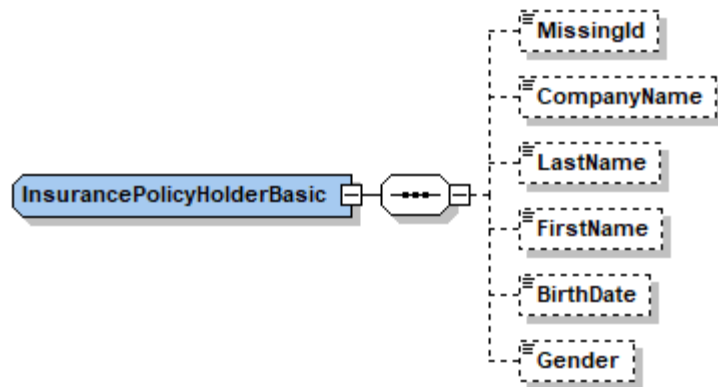

Data group details:

Data designation	Type	Allowed values	V/M	Processing rule
Basic policyholder details (InsurancePolicyHolderBasic)	brtirt:InsurancePolicyHolderBasic		V/M	Mandatory data group if no identifiers where "Identifier type" is "Business ID" or "Finnish Personal Identification Number" have been specified in the "Policyholder's identifiers" data group.
The policyholder does not have a customer identifier (MissingId)	irct:true	"true"	V/M	Mandatory data if no identifiers have been specified for the policyholder in the "Policyholder's identifiers" data group.
Company name (CompanyName)	irct:String200		V/M	Mandatory data in the following cases: <ul style="list-style-type: none"> No identifier where the "Identifier type" is "Business ID" or "Finnish Personal Identification Number" has been specified in the "Policyholder's identifiers" data group, and "Last name" and "First name" have not been specified. The value of "The policyholder does not have a customer identifier" is "true", and "Last name" and "First name" have not been specified.



Data designation	Type	Allowed values	V/M	Processing rule
				This data must not be specified if "Last name" and "First name" have been specified.
Last name (LastName)	irct:String200		V/M	<p>Mandatory data in the following cases:</p> <ul style="list-style-type: none"> No identifier where the "Identifier type" is "Business ID" or "Finnish Personal Identification Number" has been specified in the "Policyholder's identifiers" data group, and "Company name" has not been specified. The value of "The policyholder does not have a customer identifier" is "true", and "Company name" has not been specified. <p>This data must not be specified if "Company name" has been specified.</p>
First name (FirstName)	irct:String100		V/M	Checked in the same way as "Last name".
Date of birth (BirthDate)	xs:date		V/M	<p>Mandatory data in the following cases:</p> <ul style="list-style-type: none"> No identifier where the "Identifier type" is "Finnish Personal Identification Number" has been specified in the "Policyholder's identifiers" data group, and "Last name" and "First name" have been specified. The value of "The policyholder does not have a customer identifier" is "true", and "Last name" and "First name" have been specified. <p>The date must not be later than the current date. The date may not be earlier than 1 January 1800.</p>
Gender (Gender)	xs:int	Codes: Gender	V/M	Mandatory data if no identifier where the "Identifier type" is "Finnish Personal Identification Number" has been specified in the "Policyholder's identifiers" data group, and "Last name" and "First name" have been specified.



2.25 Policyholder's address (Address)

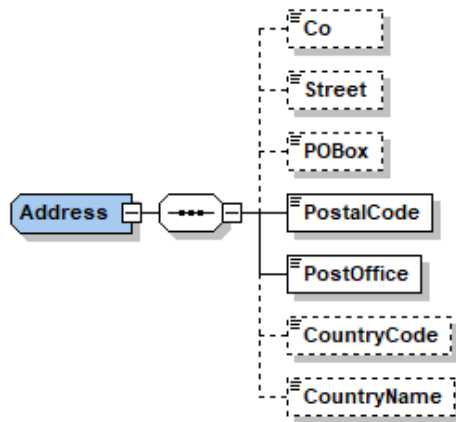

Data group details:

Data designation	Type	Allowed values	V/M	Processing rule
Policyholder's address (Address)	brtirt:Address		V/M	Mandatory data group in the following cases: <ul style="list-style-type: none"> No identifiers where "Identifier type" is "Business ID" or "Finnish Personal Identification Number" have been specified in the "Policyholder's identifiers" data group. The value of "The policyholder does not have a customer identifier" is "true".
c/o (Co)	irct:String70		V	
Street address (Street)	irct:String100		V/M	If this data group is included, either "Street address" or "P.O. Box" must be specified. Both must not be entered.
P.O. Box (POBox)	irct:String10		V/M	If this data group is included, either "Street address" or "P.O. Box" must be specified. Both must not be entered.
Postal code (PostalCode)	irct:String20		M	
City (PostOffice)	irct:String200		M	



Data designation	Type	Allowed values	V/M	Processing rule
Country code (CountryCode)	irct:String2	A two-character code in accordance with the ISO 3166 country codes. If the country is unknown, the value "99" is entered.	V/M	Mandatory data in the following cases: <ul style="list-style-type: none">• No identifiers where "Identifier type" is "Business ID" or "Finnish Personal Identification Number" have been specified in the "Policyholder's identifiers" data group.• The value of "The policyholder does not have a customer identifier" is "true".
Country name (CountryName)	irct:String70		V/M	Mandatory data if "Country code" is "99".



2.26 Deductions (Deductions)

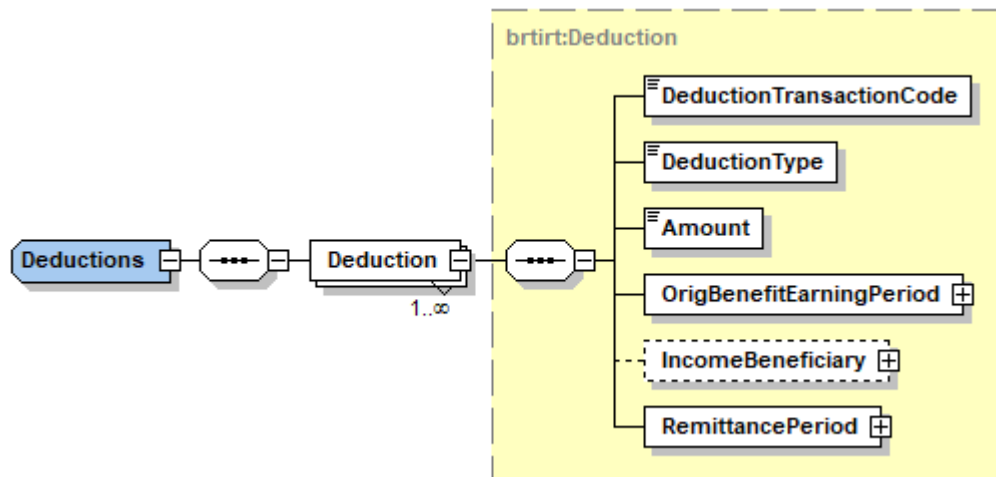

Data group details:

Data designation	Type	Allowed values	V/M	Processing rule
Deductions (Deductions)	brtirt:Deductions		V	The total amount of the "Amount of deduction" values of all deductions must not be larger than the "Amount" reported for the income type ("Income type code").
Deduction details (Deduction)	brtirt:Deduction		M	There may be several deductions.
Deduction income type code (DeductionTransactionCode)	xs:int	Codes: BenefitTransactionCode	M	The deduction income type code must be partly or entirely valid during the original earnings period of the benefit or on the payment date of DeliveryData -data group.
Type of deduction (DeductionType)	xs:int	Codes: DeductionType	M	
Amount of deduction (Amount)	irct:decimal2		M	This value must not be negative.
Earnings period of original benefit (OrigBenefitEarningPeriod)	brtirt:OrigBenefitEarningPeriod		M	



Data designation	Type	Allowed values	V/M	Processing rule
Substitute recipient details (IncomeBeneficiary)	brtirt:IncomeBeneficiary		V	
Period of calculation (RemittancePeriod)	brtirt:RemittancePeriod		M	



2.27 Earnings period of original benefit (OrigBenefitEarningPeriod)

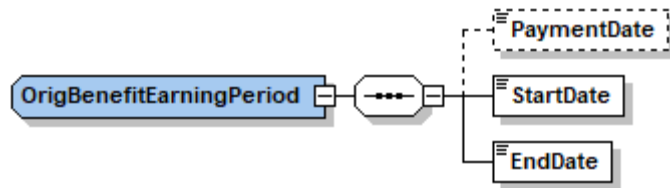

Data group details:

Data designation	Type	Allowed values	V/M	Processing rule
Earnings period of original benefit (OrigBenefitEarningPeriod)	brtirt:OrigBenefitEarningPeriod		M	The deduction income type code must be partly or entirely valid during the original earnings period of the benefit or on the payment date of DeliveryData -data group.
Date of payment or other report (PaymentDate)	xs:date		V	The date may not be earlier than 1 January 1800.
Start date (StartDate)	xs:date		M	The date may not be earlier than 1 January 1800.
End date (EndDate)	xs:date		M	The date must not be earlier than the "Start date".



2.28 Substitute recipient details (IncomeBeneficiary)

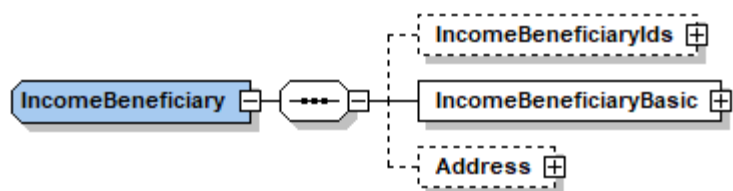

Data group details:

Data designation	Type	V/M
Substitute recipient details (IncomeBeneficiary)	brtirt:IncomeBeneficiary	V
Substitute recipient identifiers (IncomeBeneficiaryIds)	brtirt:IncomeBeneficiaryIds	V/M
Basic substitute recipient details (IncomeBeneficiaryBasic)	brtirt:IncomeBeneficiaryBasic	M
Substitute recipient's address (Address)	brtirt:Address	V/M



2.29 Substitute recipient identifiers (IncomeBeneficiaryIds)

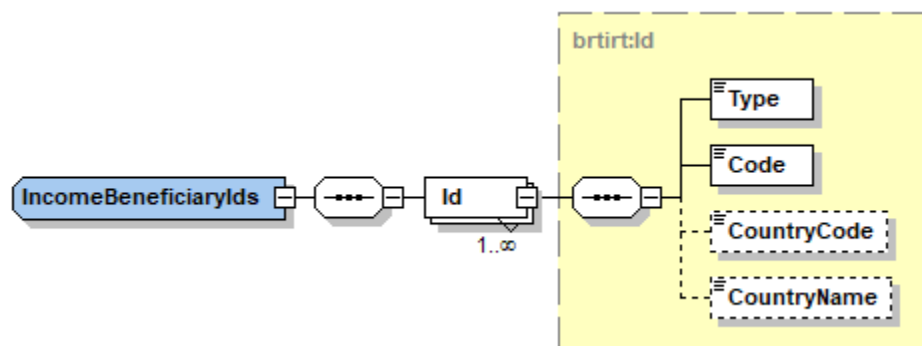

Data group details:

Data designation	Type	Allowed values	V/M	Processing rule
Substitute recipient identifiers (IncomeBeneficiaryIds)	brtirt:IncomeBeneficiaryIds		V/M	<p>Mandatory data group if "The substitute recipient does not have a customer identifier" has not been specified. The data group must not be included if "The substitute recipient does not have a customer identifier" has been specified.</p> <p>If the "Action type" is "Replacement report", the data should match that of the report's previous version.</p> <p>If multiple identifiers have been given in the data group, the identifier types cannot be the same. The same combination of identifier type and country code cannot be entered multiple times. There can only be one identifier type of "Finnish Personal Identification Number" or "Finnish Business ID" in the data group.</p>
Substitute recipient identifier (Id)	brtirt:Id		M	A substitute recipient can have several identifiers.



				If the substitute recipient is given both a Business ID and a Finnish Personal Identification Number, the identifiers must refer to the same customer.
Identifier type (Type)	xs:int	Codes: IdType	M	
Identifier (Code)	irct:String30		M	<p>If the "Identifier type" is "Finnish Personal Identification Number", the identifier must exist (according to information from the Population Information System (VTJ)).</p> <p>If the "Identifier type" is "Business ID", the identifier must exist (according to information from the Business Information System (YTJ)).</p> <p>If the "Identifier type" is other than "Business ID" or "Finnish Personal Identification Number" identifier must not be Finnish personal identification number or Business ID.</p> <p>The data must not begin or end with non-printable whitespace characters, such as spaces. The data cannot contain non-printable whitespace characters, excluding space.</p>
Country code (CountryCode)	irct:String2	A two-character code in accordance with the ISO 3166 country codes. If the country is unknown, the value "99" is entered.	V/M	<p>Mandatory data if "Identifier type" is other than "Business ID" or "Finnish Personal Identification Number".</p> <p>Country code "FI" must not be specified, if the specified "Identifier type" is other than "Business ID", "Finnish Personal Identification Number" or "Other identifier".</p> <p>If the "Identifier type" is set as "Finnish Personal Identification Number" or "Finnish Business ID", the country code can only be "FI".</p>
Country name (CountryName)	irct:String70		V/M	Mandatory data if "Country code" is "99".



2.30 Basic substitute recipient details (IncomeBeneficiaryBasic)

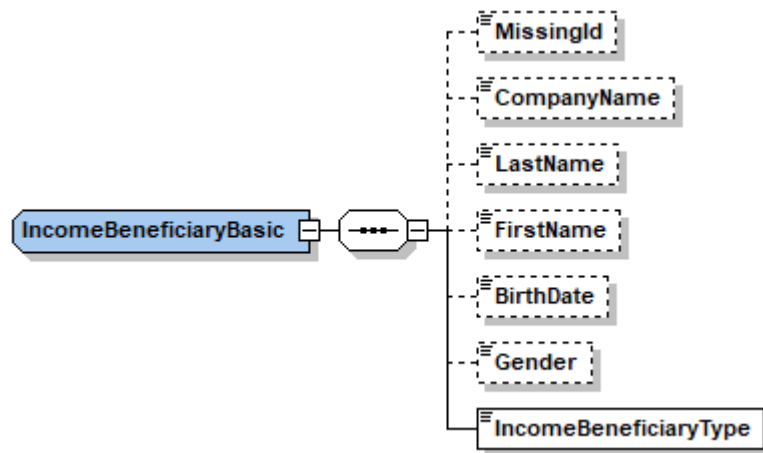

Data group details:

Data designation	Type	Allowed values	V/M	Processing rule
Basic substitute recipient details (IncomeBeneficiaryBasic)	brtirt:IncomeBeneficiaryBasic		M	
The substitute recipient does not have a customer identifier (MissingId)	irct:true	"true"	V/M	Mandatory data if no identifiers have been specified for the substitute recipient in the "Substitute recipient identifiers" data group. If the "Action type" is "Replacement report", the data should match that of the report's previous version.
Company name (CompanyName)	irct:String200		V/M	Mandatory data in the following cases: <ul style="list-style-type: none"> No identifier where the "Identifier type" is "Business ID" or "Finnish Personal Identification Number" has been specified in the "Substitute recipient identifiers" data group, and "Last name" and "First name" have not been specified.



				<ul style="list-style-type: none"> The value of "The substitute recipient does not have a customer identifier" is "true", and "Last name" and "First name" have not been specified. <p>This data must not be specified if "Last name" and "First name" have been specified.</p>
Last name (LastName)	irct:String200		V/M	<p>Mandatory data in the following cases:</p> <ul style="list-style-type: none"> No identifier where the "Identifier type" is "Business ID" or "Finnish Personal Identification Number" has been specified in the "Substitute recipient identifiers" data group, and "Company name" has not been specified. The value of "The substitute recipient does not have a customer identifier" is "true", and "Company name" has not been specified. <p>This data must not be specified if "Company name" has been specified.</p>
First name (FirstName)	irct:String100		V/M	Checked in the same way as "Last name".
Date of birth (BirthDate)	xs:date		V/M	<p>Mandatory data in the following cases:</p> <ul style="list-style-type: none"> No identifier where the "Identifier type" is "Finnish Personal Identification Number" has been specified in the "Substitute recipient identifiers" data group, and "Last name" and "First name" have been specified. The value of "The substitute recipient does not have a customer identifier" is "true", and "Last name" and "First name" have been specified. <p>The date must not be later than the current date. The date may not be earlier than 1 January 1800.</p>
Gender (Gender)	xs:int	Codes: Gender	V/M	Mandatory data if no identifier where the "Identifier type" is "Finnish Personal Identification Number" has been specified



				in the "Substitute recipient identifiers" data group, and "Last name" and "First name" have been specified.
Type of substitute recipient (IncomeBeneficiaryType)	xs:int	Codes: IncomeBeneficiaryType	M	



2.31 Substitute recipient's address (Address)

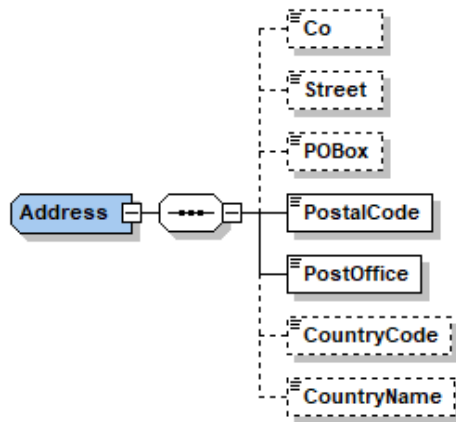

Data group details:

Data designation	Type	Allowed values	V/M	Processing rule
Substitute recipient's address (Address)	brtirt:Address		V/M	Mandatory data in the following cases: <ul style="list-style-type: none"> No identifiers where "Identifier type" is "Business ID" or "Finnish Personal Identification Number" have been specified in the "Substitute recipient identifiers" data group. The value of "The substitute recipient does not have a customer identifier" is "true".
c/o (Co)	irct:String70		V	
Street address (Street)	irct:String100		V/M	If this data group is included, either "Street address" or "P.O. Box" must be specified. Both must not be entered.
P.O. Box (POBox)	irct:String10		V/M	If this data group is included, either "Street address" or "P.O. Box" must be specified. Both must not be entered.
Postal code (PostalCode)	irct:String20		M	



City (PostOffice)	irct:String200		M	
Country code (CountryCode)	irct:String2	A two-character code in accordance with the ISO 3166 country codes. If the country is unknown, the value "99" is entered.	V/M	Mandatory data in the following cases: <ul style="list-style-type: none"> • No identifiers where "Identifier type" is "Business ID" or "Finnish Personal Identification Number" have been specified in the "Substitute recipient identifiers" data group. • The value of "The substitute recipient does not have a customer identifier" is "true".
Country name (CountryName)	irct:String70		V/M	Mandatory data if "Country code" is "99".



2.32 Period of calculation (RemittancePeriod)

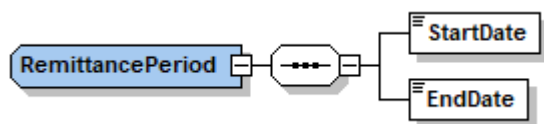

Data group details:

Data designation	Type	Allowed values	V/M	Processing rule
Period of calculation (RemittancePeriod)	brtirt:RemittancePeriod		M	
Start date (StartDate)	xs:date		M	The date may not be earlier than 1 January 1800.
End date (EndDate)	xs:date		M	The date must not be earlier than the "Start date".

