

Data delivery – Schemas – Earnings payment reports 2026

Incomes Register Unit

Version history

Version	Date	Description
1.0	27/5/2025	<p>Published a version of the document containing the 2026 changes to the data contents. The changes apply when the payment date of the income is on 1 January 2026 or later.</p> <p>Added Pension provider code 27 to the processing rules for data groups Employment period (EmploymentPeriods) and Termination of employment (EmploymentEndings).</p> <p>Added a new processing rule to Termination of employment (EmploymentEndings) data “If ‘Earnings-related pension provider code’ is 27, the report must include one reason for termination in accordance with the ‘Bank of Finland codes’ reason codeset. In addition, a report can always include a reason for termination in accordance with the ‘Incomes Register codes’ reason codeset.” in the data group Reason for the termination of employment (EmploymentEnding).</p> <p>Added a new processing rule to Termination of employment (EmploymentEndings) data “A reason for termination in accordance with the Keva codes reason codeset and a reason for termination in accordance with the Bank of Finland reason codeset cannot be given on the same report.” in the data group Reason for the termination of employment (EmploymentEnding).</p> <p>Removed the processing rule “An income earner can have several grounds for registration but only one value in accordance with the “Type of registration grounds” data item.” from Grounds for registration (EmploymentReg) from the data group Employment registration (EmploymentRegs).</p> <p>Added a new processing rule “An income earner can only have one ground for registration at a time.” to Grounds for registration (EmploymentReg) in the data group Employment registration (EmploymentRegs).</p> <p>Removed the processing rule “If the “Type of identifier” is “Other identifier”, the identifier must not be a Finnish Business ID or a Finnish Personal Identification Number.” in the following data groups:</p> <ul style="list-style-type: none"> • Payer identifiers (PayerIds) • Employer identifier (EmployerId) • Representative identifiers (RepresentativeIds) • Employer identifiers (FinServiceRecipientIds) • Principal identifiers (ServiceRecipientIds) • Income earner identifiers (IncomeEarnerIds)



Version	Date	Description
		<p>Added a processing rule “If the "Identifier type" is other than "Business ID" or "Finnish Personal Identification Number" identifier must not be Finnish personal identification number or Business ID”.</p> <p>for the following data groups:</p> <ul style="list-style-type: none"> • Record owner (DeliveryDataOwner) • Payer identifiers (PayerIds) • Employer identifier (EmployerId) • Income earner identifiers (IncomeEarnerIds) • Occupational accident insurance company identifier (AcInsProvId) • Representative identifiers (RepresentativeIds) • Employer identifiers (FinServiceRecipientIds) • Principal identifiers (ServiceRecipientIds)
		<p>Added a processing rule “Country code "FI" must not be specified, if the specified "Identifier type" is other than "Business ID", "Finnish Personal Identification Number" or "Other identifier””.</p> <p>for the following data groups:</p> <ul style="list-style-type: none"> • Record owner (DeliveryDataOwner) • Payer identifiers (PayerIds) • Employer identifier (EmployerId) • Income earner identifiers (IncomeEarnerIds) • Occupational accident insurance company identifier (AcInsProvId) • Representative identifiers (RepresentativeIds) • Employer identifiers (FinServiceRecipientIds) • Principal identifiers (ServiceRecipientIds)
		<p>Removed the processing rule “The value must be a non-negative number.” from Pay for period of paid absence (Amount) from the data group Paid Absence (PaidAbsence)</p> <p>Added the processing rule “The value must be greater than 0.” to Pay for period of paid absence (Amount) to the data group Paid Absence (PaidAbsence)</p>
		<p>Added the processing rule “The value cannot be over 29 characters.” to Payment specifier (PaymentSpecifier) to the data group Paid Absence (PaidAbsence)</p>
		<p>Added the processing rule “The value cannot be over 20 characters.” to Payment's reference number (PaymentRef) to the data group Paid Absence (PaidAbsence)</p>



Version	Date	Description
		<p>Added a new processing rule for Income type codes (TransactionCode) in the General details on the income type (TransactionBasic) data group: If the “Income type code” is 321-325, a Type of exception to insurance corresponding the chosen income type cannot be given on the same report:</p> <ul style="list-style-type: none"> • Income type 321 and Type of exception to insurance code No obligation to provide insurance (earnings-related pension, health, unemployment or accident and occupational disease insurance), No obligation to provide insurance (earnings-related pension insurance), No obligation to provide insurance (unemployment insurance), No obligation to provide insurance (accident and occupational disease insurance) or No obligation to provide insurance (health insurance) cannot be given on the same report. • Income type 322 and Type of exception to insurance code No obligation to provide insurance (earnings-related pension, health, unemployment or accident and occupational disease insurance), No obligation to provide insurance (earnings-related pension insurance) cannot be given on the same report. • Income Type 323 and Type of exception to insurance code No obligation to provide insurance (earnings-related pension, health, unemployment or accident and occupational disease insurance), No obligation to provide insurance (unemployment insurance) cannot be given on the same report. • Income Type 324 and Type of exception to insurance code No obligation to provide insurance (earnings-related pension, health, unemployment or accident and occupational disease insurance), No obligation to provide insurance (accident and occupational disease insurance) cannot be given on the same report. • Income Type 325 and Type of exception to insurance code No obligation to provide insurance (earnings-related pension, health, unemployment or accident and occupational disease insurance), No obligation to provide insurance (health insurance) cannot be given on the same report.
		<p>Added a new processing rule “If multiple identifiers have been given in the data group, the identifier types cannot be the same. The same combination of identifier type and country code cannot be entered multiple times. There can only be one identifier type of “Finnish Personal Identification Number” or “Finnish Business ID” in the data group.” to the following data groups:</p> <ul style="list-style-type: none"> • Payer identifiers (PayerIds) • Income earner identifiers (IncomeEarnerIds) • Representative identifiers (RepresentativeIds) • Employer identifiers (FinServiceRecipientIds) • Principal identifiers (ServiceRecipientIds)



Version	Date	Description
		<p>Removed the processing rule “If several Finnish Personal Identification Numbers have been issued to the income earner, the birth date derived from the Personal Identification Numbers must be the same for all Personal Identification Numbers.” from the data group Income earner identifiers (IncomeEarnerIds)</p> <p>Added a new processing rule “If the “Identifier type” is set as “Finnish Personal Identification Number” or “Finnish Business ID” the country code can only be “FI”.” to the Country Code (CountryCode) data in the following data groups:</p> <ul style="list-style-type: none"> • Record owner (DeliveryDataOwner) • Record submitter (DeliveryDataSender) • Record creator (DeliveryDataCreator) • Payer identifiers (PayerIds) • Employer identifier (EmployerId) • Income earner identifiers (IncomeEarnerIds) • Occupational accident insurance company identifier (AccInsProvId) • Representative identifiers (RepresentativeIds) • Employer identifiers (FinServiceRecipientIds) • Principal identifiers (ServiceRecipientIds)
		<p>Added new processing rules to Type of additional income earner (IncomeEarnerType) data: The same earnings payment report can only have one of the following Type of additional income earner data values:</p> <ul style="list-style-type: none"> • Leased employee living abroad • Leased employee living abroad, working on board a Finnish aircraft • Leased employee living abroad, working on board a Finnish ship • Income earner did not stay longer than 183 days in Finland during the Tax-Treaty-defined sojourn period <p>Mandatory data Group if the report contains a "Form type" for "Employee leasing notice". In this case, one of the following Type of additional income earner data values must be provided:</p> <ul style="list-style-type: none"> • Leased employee living abroad • Leased employee living abroad, working on board a Finnish aircraft • Leased employee living abroad, working on board a Finnish ship <p>Two new types of additional income earner information added to Work periods in Finland (WorkPeriodsInFinland) processing rule:</p>



Version	Date	Description
		"Leased employee living abroad, working on board a Finnish aircraft" and "Leased employee living abroad, working on board a Finnish ship".
		Added a new processing rule "The data must not begin or end with non-printable whitespace characters, such as spaces. The data cannot contain non-printable whitespace characters, excluding space. The characters that are not to be used, are listed in chapter 1.2 Character set." in the following data groups: <ul style="list-style-type: none"> • Record owner (DeliveryDataOwner) • Payer identifiers (PayerIds) • Employer identifier (EmployerId) • Income earner identifiers (IncomeEarnerIds) • Occupational accident insurance company identifier (AcclnsProvId) • Representative identifiers (RepresentativeIds) • Employer identifiers (FinServiceRecipientIds) • Principal identifiers (ServiceRecipientIds)
1.1	3/7/2025	The explanation for white space character set has been modified: character set is valid for Occupational accident insurance policy number and for Identifiers.
1.2	8/10/2025	Added new Payment type code: 3 (Contract pay)
		The processing rule of Paid Absence (PaidAbsence) has been updated: the new value 24 (Partial special pregnancy leave) has been added to the list of valid payment types in case of 'Payment data type' is 1 (Kela, daily allowance application)
1.3	6/11/2025	Corrected "Income type details (transactions)" to "Income type details (transaction)".
		The processing rule of Paid Absence (PaidAbsence) has been updated: value 24 (Partial special pregnancy leave) has been removed from the list of valid payment types in case of 'Payment data type' is 1 (Kela, daily allowance application)
		Updated the processing rule of Car emissions value (EmissionsValue): value can be 0, if Payment date or other reporting date is in 2026-2029
1.4	8/1/2026	The processing rule of Finnish employer (FinServiceRecipient) has been updated: only one Employer identifier (Id) can be specified.
1.5	6/2/2026	The processing rule of Signature (Signature) has been updated: The element is not allowed with records submitted through the upload/download service.





CONTENTS

1	General	10
1.1	Schema	10
1.2	Character set	10
1.3	Dates and times.....	12
1.4	Document reading instructions.....	14
1.5	Changes to the processing rules and data contents in 2022	14
2	Earnings payment reports (WageReportsToIR)	15
2.1	Record data (DeliveryData)	18
2.2	Pay period (PaymentPeriod)	22
2.3	Contact persons for the record (ContactPersons)	24
2.4	Payer details (Payer)	26
2.5	Payer identifiers (PayerIds)	27
2.6	Basic payer details (PayerBasic)	30
2.7	Payer's address (Address)	32
2.8	Payer's suborganisations (SubOrgs)	34
2.9	Other payer details (PayerOther).....	36
2.10	Substitute payer (SubstitutePayer)	37
2.11	Reports data (Reports)	40
2.12	Service data (ReportData)	41
2.13	Income earner details (IncomeEarner)	43
2.14	Income earner identifiers (IncomeEarnerIds)	45
2.15	Basic income earner details (IncomeEarnerBasic)	48
2.16	Income earner's addresses (Addresses).....	50
2.17	Income earner's suborganisations (SubOrgs)	52
2.18	Employment relationship data (Employment).....	53
2.19	Occupation (Professions)	57
2.20	Employment registration (EmploymentRegs).....	61
2.21	Place of business (PlaceOfBusiness).....	63
2.22	Earnings-related pension insurance (PensionInsurance).....	65
2.23	Occupational accident insurance (AccidentInsurance).....	68



2.24 Insurance exceptions (InsuranceExceptions).....	70
2.25 International situations (InternationalData).....	72
2.26 Other details (IncomeEarnerOther).....	74
2.27 Income types (Transactions).....	77
2.28 General details on the income type (TransactionBasic).....	80
2.29 Insurance information (InsuranceData).....	84
2.30 Earnings periods (EarningPeriods).....	87
2.31 Unit of the wages (UnitWages).....	88
2.32 Car benefit (CarBenefit).....	89
2.33 Meal benefit (MealBenefit).....	90
2.34 Other fringe benefit (Otherbenefit).....	91
2.35 Seafarer's income (SailorIncome).....	92
2.36 Additional details on recovery (RecoveryData).....	93
2.37 Daily allowance (DailyAllowance).....	94
2.38 Kilometre allowance (tax-exempt) (KmAllowance).....	95
2.39 Six-month rule (SixMonthRule).....	96
2.40 Details on foreign leased workforce (ForeignLeasedWork).....	97
2.41 Representative (Representative).....	98
2.42 Finnish employer (FinServiceRecipient).....	101
2.43 Stay periods in Finland (StayPeriodsInFinland).....	103
2.44 Work periods in Finland (WorkPeriodsInFinland).....	104
2.45 Countries of work (WorkCountries).....	106
2.46 Districts of work (WorkMunicipalities).....	108
2.47 Address in country of work (WorkCountryAddress).....	109
2.48 Principal (ServiceRecipient).....	111
2.49 Stay periods in country of work (StayPeriodsAbroad).....	114
2.50 Work periods abroad (WorkPeriodsAbroad).....	115
2.51 Other remunerations and benefits (Remunerations).....	116
2.52 Absences (Absence).....	117
2.53 Unpaid absence (UnpaidAbsence).....	118
2.54 Paid absence (PaidAbsence).....	119



1 GENERAL

1.1 Schema

Earnings payment reports are submitted to the Incomes Register using the **WageReportsToIR** schema.

The namespaces of the schema are as follows:

File name	Prefix	Namespace
	xmlns:xs	http://www.w3.org/2001/XMLSchema
WageReportsToIR.xsd	xmlns:wrtir	http://www.tulorekisteri.fi/2017/1/WageReportsToIR
WageReportsToIRTypes.xsd	xmlns:wrtirt	http://www.tulorekisteri.fi/2017/1/WageReportsToIRTypes
IRCommonTypes.xsd	xmlns:irct	http://www.tulorekisteri.fi/2017/1/IRCommonTypes
xmldsig-core-schema.xsd	xmlns:ds	http://www.w3.org/2000/09/xmldsig#

Empty elements are not allowed in the messages. If an element receives no value, the element is left out of the message entirely. Empty character strings are also not allowed, i.e., the minimum length of all values is 1.

1.2 Character set

The schemas of the Incomes Register use UTF-8, which is the default character set of XML. The file must not contain the Byte Order Mark (BOM) character.

The following table presents the requirements for the conversion of special characters appearing in messages.

Character	Description	Presentation format as an entity
&	ampersand	& conversion is mandatory
<	less than	< conversion is mandatory
>	greater than	> conversion is not mandatory, but conforms with best practices
'	apostrophe	' conversion is not mandatory, but conforms with best practices
"	quotation mark	" conversion is not mandatory, but conforms with best practices



--	double hyphen	This character must not appear in an XML file
/*	slash asterisk	This character must not appear in an XML file
&#	ampersand hash	This character must not appear in an XML file

A limited character set is allowed for **reference data**. The allowed characters for the reference data listed below are the numbers 0-9, the letters a-z and A-Z and the symbols " _ " and "-".

- Record owner's record reference (DeliveryId)
- Payer's report reference (ReportId)
- Subscriber's primary subscription reference (MainSubscriptionId)
- Subscriber's secondary subscription reference (SubscriptionId)
- Sender's message reference (MessageId)

In the following data items, upper and lowercase characters are significant:

- Country codes in all data groups (for example, "DE" is interpreted to be a different code than "De").
- Customer IDs in all data groups (for example, "150172-999H" is interpreted to be a different ID than "150172-999h").

The following table shows the non-printable whitespace characters that are not to be used in the Occupational accident insurance policy number (AcInsPolicyNo) or in the Identifier (Code):

Unicode-tecken	Beskrivning	Format som entitet
U+0020	Mellanslag – Space	 tai
U+0009	Tabulator		 tai 	 tai &Tab
U+00A0	Hårt mellanslag, det vill säga No-break Space	 tai tai &NonBreakingSpace
U+180E	Mongolian Vowel Separator	᠎ eller ᠎
U+2000	En Quad	  eller  
U+2001	Em Quad	  eller  
U+2002	Halvfyrkant, det vill säga En Space	  eller   eller &ensp



U+2003	Kvadrat, Em-Mellanslag, det vill säga Em Space	  eller   eller &emsp
U+2004	Three-Per-Em Space	  eller   eller &emsp13
U+2005	Fjärdedelsfyrkant, det vill säga Four-Per-Em Space	  eller   eller &emsp14
U+2006	Six-Per-Em Space	  eller  
U+2007	Figure Space	  eller   eller
U+2008	Punctuation Space	  eller   eller &puncsp
U+2009	Fast mellanslag, det vill säga Thin Space	  eller   eller &ThinSpace
U+200A	Hårspatie, det vill säga Hair Space	  eller   eller &VeryThinSpace
U+200B	Noll avstånd, det vill säga Zero Width Space	​ eller ​ eller &NegativeVeryThinSpace
U+202F	Smalt fast mellanrum, det vill säga Narrow No-Break Space	  eller  
U+205F	Medium Mathematical Space	  eller   eller &MediumSpace
U+3000	Ideographic Space	　 eller 　
U+FEFF	Zero Width No-Break	﻿ eller ﻿
U+000A	Line Feed (Lf)	
 eller
 eller &NewLine
U+000B	Vertical Tabulation (Vt)	 eller
U+000C	Form Feed (Ff)	 eller 
U+000D	Carriage Return (Cr)	 eller 
U+0085	Next Line (Nel)	… eller …
U+2028	Line Separator (Ls)	  eller  
U+2029	Paragraph Separator (Ps)	  eller  

1.3 Dates and times

Dates (data type xs:date) must not include time zone information. Example of a date:

<StartDate>2017-05-11</StartDate>

Data elements containing times of day (data types xs:dateTime and xs:time) must include the time zone.

Example in the Finnish time zone (standard time, UTC+2):

<Timestamp>2017-05-11T08:00:00+02:00</Timestamp>

<Time>08:00:00+02:00</Time>

Example in UTC time (UTC+0):

<Timestamp>2017-05-11T6:00:00Z</Timestamp>

<Time>06:00:00Z</Time>



1.4 Document reading instructions

In the document diagrams, the 0 .. ∞ marking in the bottom right-hand corner of an element means that the element may appear several times, or not at all. The 1 .. ∞ marking means that the element may appear several times but must always appear at least once. The mandatory elements are highlighted with a solid border line and voluntary elements with a dashed border line.

In the document tables, the mandatory or voluntary nature of the elements is depicted with the following markings:

V/M	Description
V	The element is always voluntary.
M	The element is mandatory if its "parent element" is included. Example: The data group "Seafarer's income" (SailorIncome) is voluntary (V), but if it is included, the data group item "Payment is seafarer's income" (SailorIncome) must be specified (M).
V/M	The element is conditionally mandatory. The data processing rules describe the situations in which the element is mandatory.

In some elements, messages use a limited range of values, i.e. codes. The possible values for these codes are described in the "Codes" and "Wages – Codes – Income types" documents. This document refers to the values presented in the codesets using the term "codes".

1.5 Changes to the processing rules and data contents in 2022

The changes to the processing rules and data contents included in the annual changes for 2022 will be in effect in accordance with the date of the payment. The new data contents and processing rules will be applied to reports in which the payment date or other reporting date is 1 January 2022 or later. If the payment date is earlier than 1 January 2022, the schema description of the year of the payment date will be applied.



2 EARNINGS PAYMENT REPORTS (WAGEREPORTSTOIR)

The general structure of a record containing earnings payment reports and submitted to the Incomes Register is as follows:

Data group name	Type	V/M
Record data (DeliveryData)	wrtirt:DeliveryData	M
Pay period (PaymentPeriod)	wrtirt:PaymentPeriod	M
Contact persons for the record (ContactPersons)	wrtirt:ContactPersons	M
Payer details (Payer)	wrtirt:Payer	M
Payer identifiers (PayerIds)	wrtirt:PayerIds	V/M
Basic payer details (PayerBasic)	wrtirt:PayerBasic	V/M
Payer's address (Address)	wrtirt:Address	V/M
Payer's suborganisations (SubOrgs)	wrtirt:SubOrgs	V/M
Other payer details (PayerOther)	wrtirt:PayerOther	V
Substitute payer (SubstitutePayer)	wrtirt:SubstitutePayer	V
Reports data (Reports)	wrtirt:Reports	M
Report data (Report)	wrtirt:Report	M
Service data (ReportData)	wrtirt:ReportData	M
Income earner details (IncomeEarner)	wrtirt:IncomeEarner	M
Income earner identifiers (IncomeEarnerIds)	wrtirt:IncomeEarnerIds	V/M
Basic income earner details (IncomeEarnerBasic)	wrtirt:IncomeEarnerBasic	V/M
Income earner's addresses (Addresses)	wrtirt:Addresses	V/M
Income earner's suborganisations (SubOrgs)	wrtirt:Suborgs	V
Employment relationship data (Employment)	wrtirt:Employment	V/M
Occupation (Professions)	wrtirt:Professions	V/M
Employment registration (EmploymentRegs)	wrtirt:EmploymentRegs	V/M
Place of business (PlaceOfBusiness)	wrtirt:PlaceOfBusiness	V
Earnings-related pension insurance (PensionInsurance)	wrtirt:PensionInsurance	V/M
Occupational accident insurance (AccidentInsurance)	wrtirt:AccidentInsurance	V



Data group name	Type	V/M
Insurance exceptions (InsuranceExceptions)	wrtirt:InsuranceExceptions	V/M
International situations (InternationalData)	wrtirt:InternationalData	V
Other details (IncomeEarnerOther)	wrtirt:IncomeEarnerOther	V
Income types (Transactions)	wrtirt:Transactions	V
Income type details (Transaction)	wrtirt:Transaction	M
General details on the income type (TransactionBasic)	wrtirt:TransactionBasic	M
Insurance information (InsuranceData)	wrtirt:InsuranceData	V
Earnings periods (EarningPeriods)	wrtirt:EarningPeriods	V
Unit of the wages (UnitWages)	wrtirt:UnitWages	V
Car benefit (CarBenefit)	wrtirt:CarBenefit	V/M
Meal benefit (MealBenefit)	wrtirt:MealBenefit	V
Other fringe benefit (Otherbenefit)	wrtirt:OtherBenefit	V/M
Seafarer's income (SailorIncome)	wrtirt:SailorIncome	V
Additional details on recovery (RecoveryData)	wrtirt:RecoveryData	V/M
Daily allowance (DailyAllowance)	wrtirt:DailyAllowance	V/M
Kilometre allowance (tax-exempt) (KmAllowance)	wrtirt:KmAllowance	V
Six-month rule (SixMonthRule)	wrtirt:SixMonthRule	V
Details on foreign leased workforce (ForeignLeasedWork)	wrtirt:ForeignLeasedWork	V/M
Representative (Representative)	wrtirt:Representative	V
Finnish employer (FinServiceRecipient)	wrtirt:FinServiceRecipient	V/M
Stay periods in Finland (StayPeriodInFinland)	wrtirt:StayPeriodsInFinland	V/M
Work periods in Finland (WorkPeriodsInFinland)	wrtirt:WorkPeriodsInFinland	V/M
Countries of work (WorkCountries)	wrtirt:WorkCountries	V/M
Country of work (WorkCountry)	wrtirt:WorkCountry	M
Districts of work (WorkMunicipalities)	wrtirt:WorkMunicipalities	V
Address in country of work (WorkCountryAddress)	wrtirt:WorkCountryAddress	V



Data group name	Type	V/M
Principal (ServiceRecipient)	wrtirt:ServiceRecipient	V/M
Stay periods in country of work (StayPeriodsAbroad)	wrtirt: StayPeriodsAbroad	V/M
Work periods abroad (WorkPeriodsAbroad)	wrtirt: WorkPeriodsAbroad	V/M
Other remunerations and benefits (Remunerations)	wrtirt: Remunerations	V
Absences (Absence)	wrtirt:Absence	V
Unpaid absence (UnpaidAbsence)	wrtirt:UnpaidAbsence	V/M
Paid absence (PaidAbsence)	wrtirt:PaidAbsence	V/M
Signature (Signature)	xsig:SignatureType	V/M



2.1 Record data (DeliveryData)

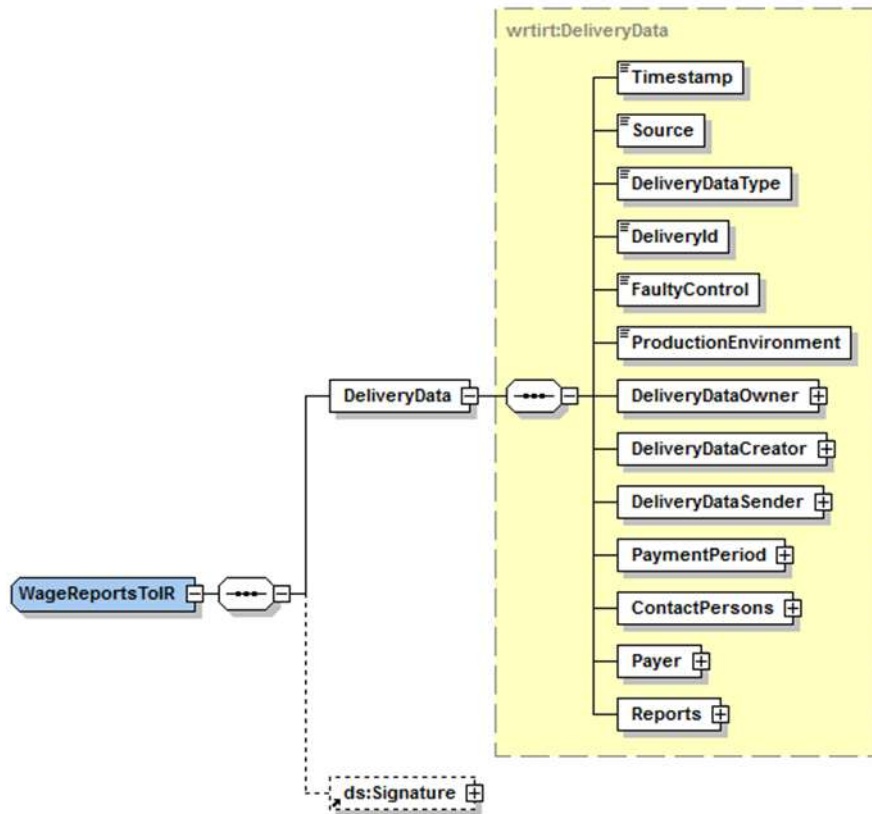

Data group details:

Data designation	Type	Allowed values	V/M	Processing rule
Record data (DeliveryData)	wrtirt:DeliveryData		M	
Time of record creation (Timestamp)	xs:dateTime		M	
Data source (Source)	irct:String30		M	



Data designation	Type	Allowed values	V/M	Processing rule
Record type (DeliveryDataType)	xs:int	Codes: DeliveryDataType and value 100 from it	M	
Record owner's (payer's) record reference (DeliveryId)	irct:String40		M	The record owner's record reference must uniquely identify all records of a specific record owner (DeliveryDataOwner) containing earnings payment reports (DeliveryDataType=100).
Rule for processing invalid data (reports) (FaultyControl)	xs:int	Codes: FaultyControl	M	If the record contains invalid reports, this entry determines whether to reject only the invalid reports in the record or the entire record.
Production environment (ProductionEnvironment)	irct:trueOrFalse	Codes: ProductionEnvironm ent	M	If the value is "true", the data must have been delivered to the Incomes Register's production environment. If the value is "false", the data must have been delivered to the Incomes Register's test environment.
Record owner (DeliveryDataOwner)	wrtirt:Id		M	<p>Processing rules related to data items Record owner, Record creator and Record submitter:</p> <p>The payer has a customer ID and the payer reports the data: At least one identifier has been specified in the data group Payer identifiers. The data item <i>Record owner</i> must be one of the payer identifiers. If a business ID has been specified in the data group Payer identifiers, it must be specified as the Record owner. The Record owner (= payer) must be specified as the <i>Record creator</i>. The Record owner (= payer) must be specified as the <i>Record submitter</i>.</p> <p>The payer has a customer ID and the service provider submits the data on behalf of the payer:</p>



Data designation	Type	Allowed values	V/M	Processing rule
				<p>At least one identifier has been specified in the data group Payer identifiers. The data item <i>Record owner</i> must be one of the payer identifiers. If a business ID has been specified in the data group Payer identifiers, it must be specified as the Record owner.</p> <p>The identifier of the service provider must be specified as the <i>Record creator</i>. If the service provider has a business ID, it must be specified. It must be specified in the Incomes Register that the service provider has the right to submit records on behalf of others.</p> <p>The Record creator (= service provider) must be specified as the <i>Record submitter</i>.</p> <p>The payer has no customer ID and the service provider submits the data on behalf of the payer:</p> <p>The value of the data item "The payer does not have a customer ID" is "true".</p> <p>The identifier of the service provider must be specified as the <i>Record owner</i>. If the service provider has a business ID, it must be specified. It must be specified in the Incomes Register that the service provider has the right to submit records on behalf of others.</p> <p>The Record owner (= service provider) must be specified as the <i>Record creator</i>.</p> <p>The Record owner (= service provider) must be specified as the <i>Record submitter</i>.</p>
Identifier type (Type)	xs:int	Codes: IdType	M	
Identifier (Code)	irct:String30		M	If the "Identifier type" is "Business ID", the identifier must exist (according to information from the Business Information System (YTJ)).



Data designation	Type	Allowed values	V/M	Processing rule
				<p>If the "Identifier type" is "Finnish Personal Identification Number", the identifier must exist (according to information from the Population Information System (VTJ)).</p> <p>If the "Identifier type" is other than "Business ID" or "Finnish Personal Identification Number", the identifier must not be Finnish personal identification number or Business ID.</p>
Country code (CountryCode)	irct:String2	A two-character code in accordance with the ISO 3166 country codes. If the country is unknown, the value "99" is entered.	V/M	<p>Mandatory data if "Identifier type" is other than "Business ID" or "Finnish Personal Identification Number".</p> <p>Country code "FI" must not be specified, if the specified "Identifier type" is other than "Business ID", "Finnish Personal Identification Number" or "Other identifier".</p> <p>If the "Identifier type" is set as "Finnish Personal Identification Number" or "Finnish Business ID" the country code can only be "FI".</p> <p>The data must not begin or end with non-printable whitespace characters, such as spaces. The data cannot contain non-printable whitespace characters, excluding space. The characters that are not to be used, are listed in chapter 1.2 Character set.</p>
Country name (CountryName)	irct:String70		V/M	Mandatory data if "Country code" is "99".
Record creator (DeliveryDataCreator)	wrtirt:Id		M	The processing rules for Identifier type, Identifier, Country code and Country name are the same as in the Record owner (DeliveryDataOwner) data group.
Record submitter (DeliveryDataSender)	wrtirt:Id		M	The processing rules for Identifier type, Identifier, Country code and Country name are the same as in the Record owner (DeliveryDataOwner) data group.
Pay period (PaymentPeriod)	wrtirt:PaymentPeriod		M	



Data designation	Type	Allowed values	V/M	Processing rule
Contact persons for the record (ContactPersons)	wrtirt:ContactPersons		M	
Payer details (Payer)	wrtirt:Payer		M	
Reports data (Reports)	wrtirt:Reports		M	
Signature (Signature)	xsig:SignatureType		V/M	The electronic signature of the record is delivered in this data group. The record must be signed using the certificate of the party specified as the Record creator. The element is not allowed with records submitted through the upload/download service.

2.2 Pay period (PaymentPeriod)

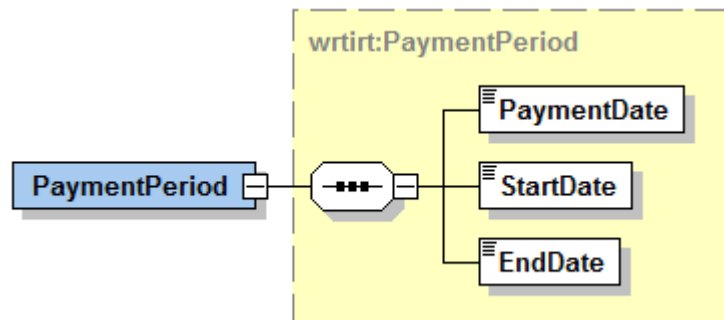

Data group details:

Data designation	Type	Allowed values	V/M	Processing rule
Pay period (PaymentPeriod)	wrtirt:PaymentPeriod		M	If the "Action type" is "Replacement report", the data should match that of the report's previous version.
Date of payment or other report (PaymentDate)	xs:date		M	The date must not be earlier than 1 January 2019 or more than 45 days later than the current date.

Data designation	Type	Allowed values	V/M	Processing rule
Start date (StartDate)	xs:date		M	The date must not be earlier than 1 January 1800.
End date (EndDate)	xs:date		M	The date must not be earlier than the "Start date".



2.3 Contact persons for the record (ContactPersons)

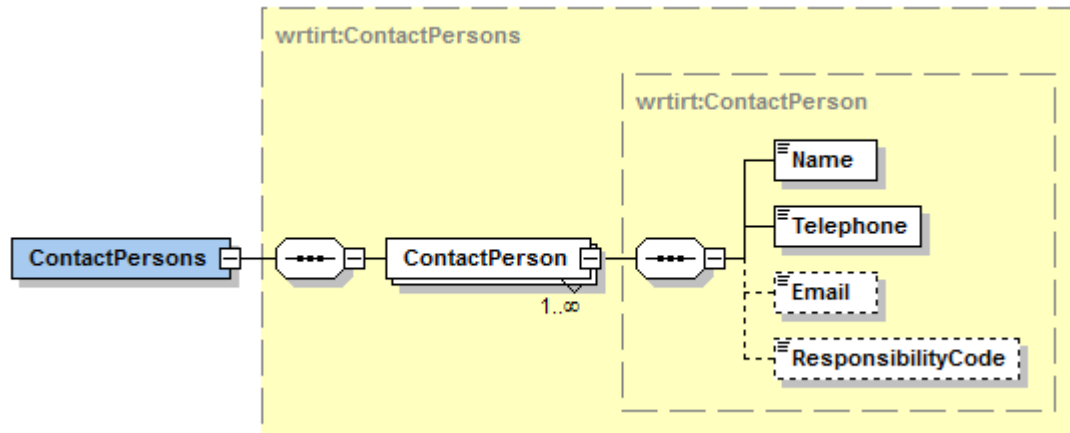

Data group details:

Data designation	Type	Allowed values	V/M	Processing rule
Contact persons for the record (ContactPersons)	wrtirt:ContactPersons		M	
Contact person for the record (ContactPerson)	wrtirt:ContactPerson		M	There may be several contact persons.
Name (Name)	irct:String200		M	
Telephone number (Telephone)	irct:String40		M	
E-mail address (Email)	irct:String70		V/M	If the 'Reimbursement application data' data group is specified for a paid absence and 1, 2 or 3 as the 'Payment data type' even in a single report in a record, you must report at least one 'Contact person for the record' for whom the 'E-mail address' and 'Field of responsibility' data items have been specified.
Field of responsibility (ResponsibilityCode)	xs:int	Codes: ResponsibilityCode	V/M	If the 'Reimbursement application data' data group is specified for a paid absence and 1, 2 or 3 as the 'Payment data type' even in a single report in a record, you must report at least one "Contact person for the record" for whom the 'E-mail address'



Data designation	Type	Allowed values	V/M	Processing rule
				and 'Field of responsibility' data items have been specified, with 'Field of responsibility' having the value 1 (Content issues).



2.4 Payer details (Payer)

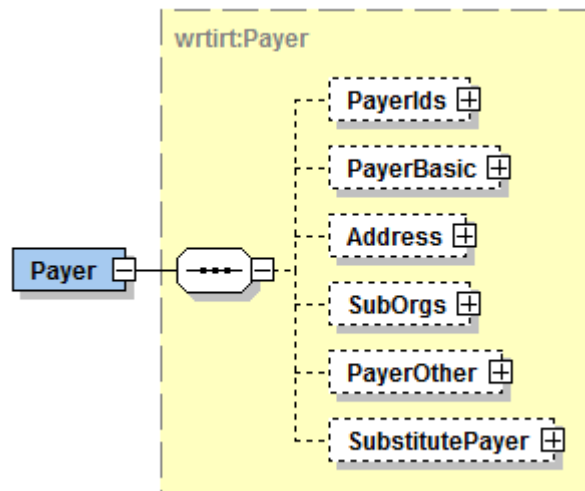

Data group details:

Data designation	Type	V/M
Payer details (Payer)	wrtirt:Payer	M
Payer identifiers (PayerIds)	wrtirt:PayerIds	V/M
Basic payer details (PayerBasic)	wrtirt:PayerBasic	V/M
Payer's address (Address)	wrtirt:Address	V/M
Payer's suborganisations (SubOrgs)	wrtirt:SubOrgs	V/M
Other payer details (PayerOther)	wrtirt:PayerOther	V
Substitute payer (SubstitutePayer)	wrtirt:SubstitutePayer	V



2.5 Payer identifiers (PayerIds)

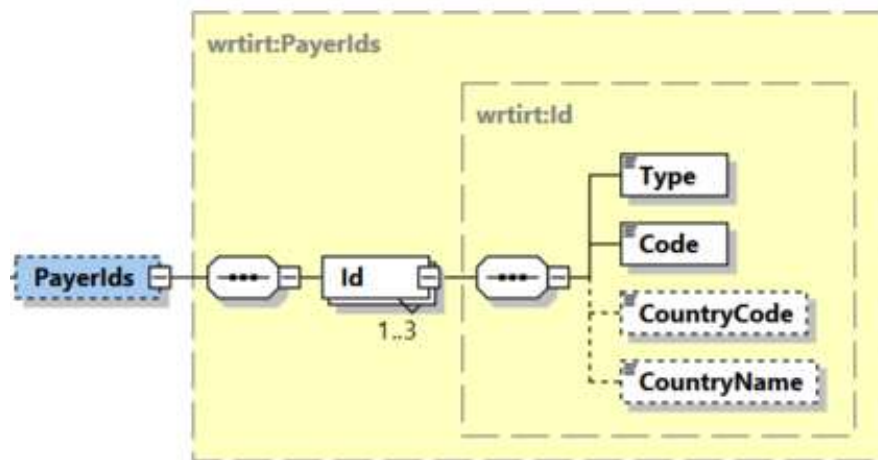

Data group details:

Data designation	Type	Allowed values	V/M	Processing rule
Payer identifiers (PayerIds)	wrtirt:PayerIds		V/M	<p>Mandatory data group, if "The payer does not have a customer ID" has not been specified.</p> <p>The data group must not be included, if "The payer does not have a customer ID" has been specified.</p> <p>If the "Action type" is "Replacement report", the data should match that of the report's previous version.</p> <p>If multiple identifiers have been given in the data group, the identifier types cannot be the same. The same combination of identifier type and country code cannot be entered multiple times. There can only be one identifier type of "Finnish Personal Identification Number" or "Finnish Business ID" in the data group.</p>



Data designation	Type	Allowed values	V/M	Processing rule
Payer's identifier (Id)	wrtirt:Id		M	<p>A payer can be given up to three payer identifiers.</p> <p>If the payer is given both a Business ID and a Finnish Personal Identification Number, the identifiers must refer to the same customer.</p> <p>The payer's and the income earner's identifiers may not be the same (none of the payer's identifiers may be the same as any of the income earner's identifiers).</p> <p>If a Business ID/Finnish Personal Identification Number has been specified for the payer, and a Business ID/Finnish Personal Identification Number has been specified for the income earner, these identifiers must not belong to the same customer (Customer has both a Business ID and a Finnish Personal Identification Number. The Business ID has been entered as the payer's ID and the Finnish Personal Identification Number as the income earner's identifier, or vice versa).</p>
Identifier type (Type)	xs:int	Codes: IdType	M	If the 'Reimbursement application data' data group is specified for a paid absence and 1, 2 or 3 as the 'Payment data type' in the report, the payer's identifier type must be 'Business ID' or 'Finnish Personal Identification Number'.
Identifier (Code)	irct:String30		M	<p>If the "Identifier type" is "Business ID", the identifier must exist (according to information from the Business Information System (YTJ)).</p> <p>If the "Identifier type" is "Finnish Personal Identification Number", the identifier must exist (according to information from the Population Information System (VTJ)).</p>



Data designation	Type	Allowed values	V/M	Processing rule
				<p>If the "Identifier type" is other than "Business ID" or "Finnish Personal Identification Number", the identifier must not be Finnish personal identification number or Business ID.</p> <p>The data must not begin or end with non-printable whitespace characters, such as spaces. The data cannot contain non-printable whitespace characters, excluding space. The characters that are not to be used, are listed in chapter 1.2 Character set.</p>
Country code (CountryCode)	irct:String2	A two-character code in accordance with the ISO 3166 country codes. If the country is unknown, the value "99" is entered.	V/M	<p>Mandatory data if "Identifier type" is other than "Business ID" or "Finnish Personal Identification Number". Country code "FI" must not be specified, if the specified "Identifier type" is other than "Business ID", "Finnish Personal Identification Number" or "Other identifier".</p> <p>If the "Identifier type" is set as "Finnish Personal Identification Number" or "Finnish Business ID" the country code can only be "FI".</p>
Country name (CountryName)	irct:String70		V/M	Mandatory data if "Country code" is "99".



2.6 Basic payer details (PayerBasic)

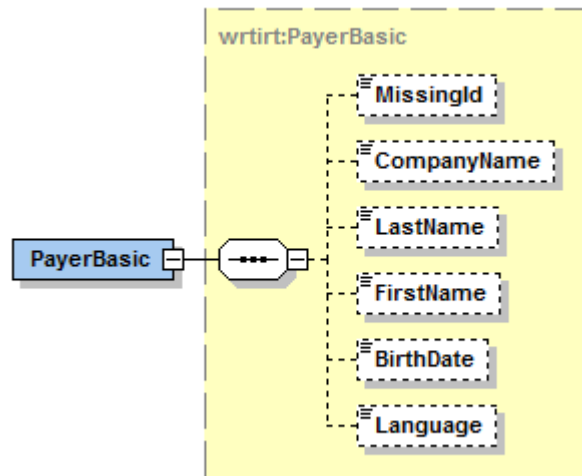

Data group details:

Data designation	Type	Allowed values	V/M	Processing rule
Basic payer details (PayerBasic)	wrtirt:PayerBasic		V/M	Mandatory data group in the following cases: <ul style="list-style-type: none"> No identifiers where "Identifier type" is "Business ID" or "Finnish Personal Identification Number" have been specified in the "Payer identifiers" data group. The value of "Payer type" is "Temporary employer (no TyEL insurance)".
The payer does not have a customer ID (MissingId)	irct:true	"true"	V/M	Mandatory data, if no identifiers have been specified in the "Payer identifiers" data group.
Company name (CompanyName)	irct:String200		V/M	Mandatory data in the following cases: <ul style="list-style-type: none"> No identifier where the "Identifier type" is "Business ID" or "Finnish Personal Identification Number" has been specified in the "Payer identifiers" data group, and "Last name" and "First name" have not been specified.



				<ul style="list-style-type: none"> • The value of "The payer does not have a customer ID" is "true", and "Last name" and "First name" have not been specified. • The value of "Payer type" is "Temporary employer (no TyEL insurance)", and "Last name" and "First name" have not been specified.
Last name (LastName)	irct:String200		V/M	Mandatory data in the following cases: <ul style="list-style-type: none"> • No identifier where the "Identifier type" is "Business ID" or "Finnish Personal Identification Number" has been specified in the "Payer identifiers" data group, and "Company name" has not been specified. • The value of "The payer does not have a customer ID" is "true", and "Company name" has not been specified. • The value of "Payer type" is "Temporary employer (no TyEL insurance)", and "Company name" has not been specified.
First name (FirstName)	irct:String100		V/M	Checked in the same way as "Last name".
Date of birth (BirthDate)	xs:date		V/M	Mandatory data in the following cases: <ul style="list-style-type: none"> • No identifier where the "Identifier type" is "Finnish Personal Identification Number" has been specified in the "Payer identifiers" data group, and "Last name" and "First name" have been specified. • The value of "The payer does not have a customer ID" is "true", and "Last name" and "First name" have been specified. <p>The date must not be later than the current date. The date must not be earlier than 1 January 1800.</p>
Contact language (Language)	xs:int	Codes: Language	V	



2.7 Payer's address (Address)

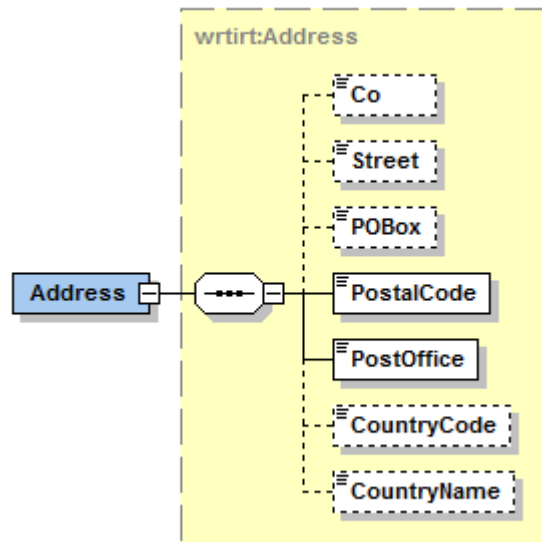

Data group details:

Data designation	Type	Allowed values	V/M	Processing rule
Payer's address (Address)	wrtirt:Address		V/M	Mandatory data group in the following cases: <ul style="list-style-type: none"> No identifiers where "Identifier type" is "Business ID" or "Finnish Personal Identification Number" have been specified in the "Payer identifiers" data group. The value of "The payer does not have a customer ID" is "true". The value of "Payer type" is "Temporary employer (no TyEL insurance)".
c/o (Co)	irct:String70		V	
Street address (Street)	irct:String100		V/M	If this data group is included, either "Street address" or "P.O. Box" must be specified. Both must not be entered.



Data designation	Type	Allowed values	V/M	Processing rule
P.O. Box (POBox)	irct:String10		V/M	If this data group is included, either "Street address" or "P.O. Box" must be specified. Both must not be entered.
Postal code (PostalCode)	irct:String20		M	
City (PostOffice)	irct:String200		M	
Country code (CountryCode)	irct:String2	A two-character code in accordance with the ISO 3166 country codes. If the country is unknown, the value "99" is entered.	V/M	Mandatory data in the following cases: <ul style="list-style-type: none"> • No identifiers where "Identifier type" is "Business ID" or "Finnish Personal Identification Number" have been specified in the "Payer identifiers" data group. • The value of "The payer does not have a customer ID" is "true". • The value of "Payer type" is "Temporary employer (no TyEL insurance)".
Country name (CountryName)	irct:String70		V/M	Mandatory data if "Country code" is "99".



2.8 Payer's suborganisations (SubOrgs)

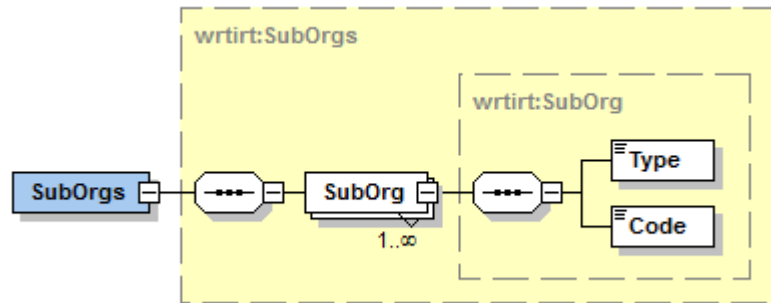

Data group details:

Data designation	Type	Allowed values	V/M	Processing rule
Payer's suborganisations (SubOrgs)	wrtirt:SubOrgs		V/M	Mandatory data group, if "Pension provider code" is 20, 30, 25, 24 or 29. In such a case, the payer's suborganisation, whose "Suborganisation's identifier type" is "Keva's submitter codes", must be specified in the data group.
Payer's suborganisation (SubOrg)	wrtirt:SubOrg		M	A payer can have several suborganisations. A payer can have only one suborganisation, conforming to the Suborganisation's identifier data item. For example: A payer can have only one suborganisation whose "Suborganisation's identifier type" is "Keva's submitter codes".
Suborganisation's identifier type (Type)	xs:int	Codes: PayerSubOrgType	M	
Suborganisation identifier (Code)	irct:String20		M	If "Earnings-related pension provider code" is 20, 30, 25, 24 or 29 and "Suborganisation's identifier type" is "Keva's submitter codes", the combination ("Suborganisation identifier", "Pension policy number") must be included in the codeset and must be valid on the date that is the value of "Payment date or other report date".



Data designation	Type	Allowed values	V/M	Processing rule
				If "Suborganisation's identifier type" is other than "Keva's submitter codes", it must be included in the specified codeset. If the codeset includes a validity period, the value must be valid on the date that is the value of "Payment date or other report date" in the specified codeset.



2.9 Other payer details (PayerOther)

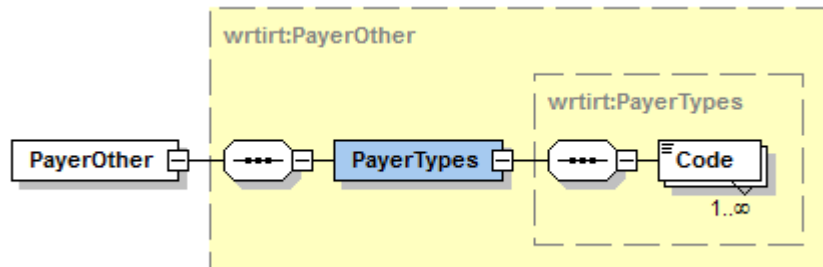

Data group details:

Data designation	Type	Allowed values	V/M	Processing rule
Other payer details (PayerOther)	wrtirt:PayerOther		V	
Payer types (PayerTypes)	wrtirt:PayerTypes		M	
Payer type (Code)	xs:int	Codes: PayerType	M	A payer can have several payer types. If the "Payer type" is "Temporary employer (no TyEL insurance)", the pension policy number must be a temporary employer's generic pension policy number in accordance with the "Pension provider code" data.



2.10 Substitute payer (SubstitutePayer)

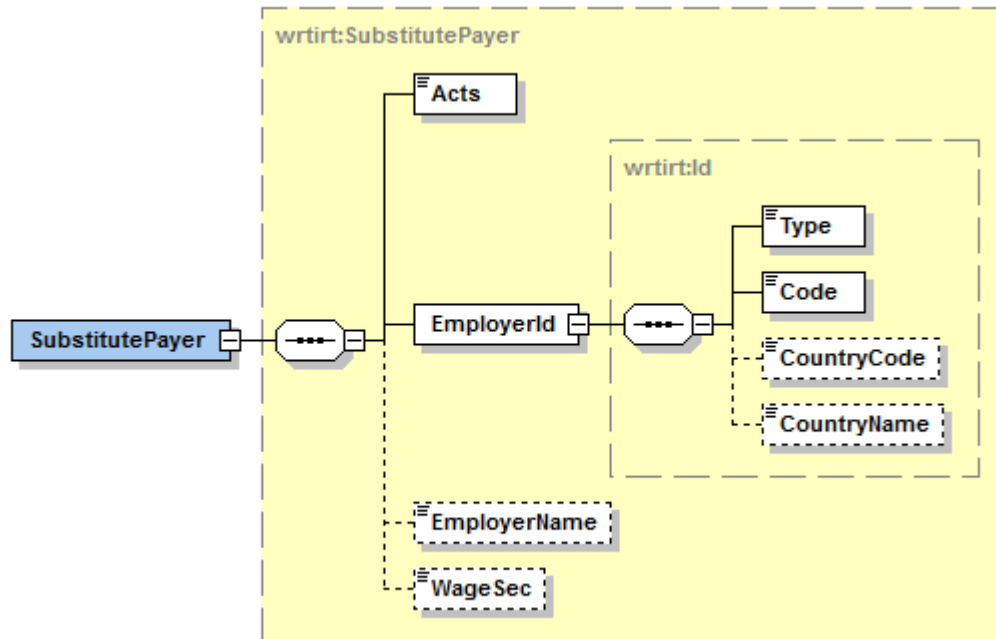

Data group details:

Data designation	Type	Allowed values	V/M	Processing rule
Substitute payer (SubstitutePayer)	wrtirt:SubstitutePayer		V	If substitute payer data is specified, at least the "Acts as a substitute payer" and "Employer identifier" data must be specified. If the "Action type" is "Replacement report", the data should match that of the report's previous version.
Acts as a substitute payer (Acts)	irct:true	"true"	M	
Employer identifier (EmployerId)	wrtirt:Id		M	
Identifier type (Type)	xs:int	Codes: IdType	M	



Data designation	Type	Allowed values	V/M	Processing rule
Identifier (Code)	irct:String30		M	<p>If the "Identifier type" is "Business ID", the identifier must exist (according to information from the Business Information System (YTJ)).</p> <p>If the "Identifier type" is "Finnish Personal Identification Number", the identifier must exist (according to information from the Population Information System (VTJ)).</p> <p>If the "Type of identifier" is "Business ID" or "Finnish Personal Identification Number", the identifier must not be the same as the identifier provided in the Payer identifiers (PayerIds) data group.</p> <p>If the "Identifier type" is other than "Business ID" or "Finnish Personal Identification Number", the identifier must not be Finnish personal identification number or Business ID.</p> <p>The data must not begin or end with non-printable whitespace characters, such as spaces. The data cannot contain non-printable whitespace characters, excluding space. The characters that are not to be used, are listed in chapter 1.2 Character set.</p>
Country code (CountryCode)	irct:String2	A two-character code in accordance with the ISO 3166 country codes. If the country is unknown, the value "99" is entered.	V/M	<p>Mandatory data if "Identifier type" is other than "Business ID" or "Finnish Personal Identification Number".</p> <p>Country code "FI" must not be specified, if the specified "Identifier type" is other than "Business ID", "Finnish Personal Identification Number" or "Other identifier."</p> <p>If the "Identifier type" is set as "Finnish Personal Identification Number" or "Finnish Business ID" the country code can only be "FI".</p>
Country name (CountryName)	irct:String70		V/M	Mandatory data if "Country code" is "99".
Employer name (EmployerName)	irct:String200		V/M	Mandatory data if "Identifier type" is other than "Business ID" or "Finnish Personal Identification Number".



Data designation	Type	Allowed values	V/M	Processing rule
Paid as wage security (WageSec)	irct:true	"true"	V	



2.11 Reports data (Reports)

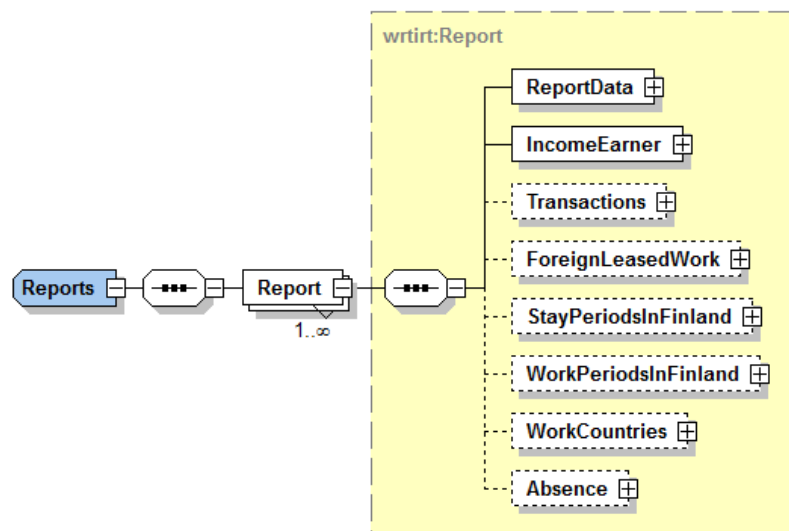

Data group details:

Data designation	Type	V/M
Reports data (Reports)	wrtirt:Reports	M
Report data (Report)	wrtirt:Report	M
Service data (ReportData)	wrtirt:ReportData	M
Income earner details (IncomeEarner)	wrtirt:IncomeEarner	M
Income types (Transactions)	wrtirt:Transactions	V
Details on foreign leased workforce (ForeignLeasedWork)	wrtirt:ForeignLeasedWork	V/M
Stay periods in Finland (StayPeriodInFinland)	wrtirt:StayPeriodsInFinland	V/M
Work periods in Finland (WorkPeriodsInFinland)	wrtirt:WorkPeriodsInFinland	V/M
Countries of work (WorkCountries)	wrtirt:WorkCountries	V/M
Absences (Absence)	wrtirt:Absence	V



2.12 Service data (ReportData)

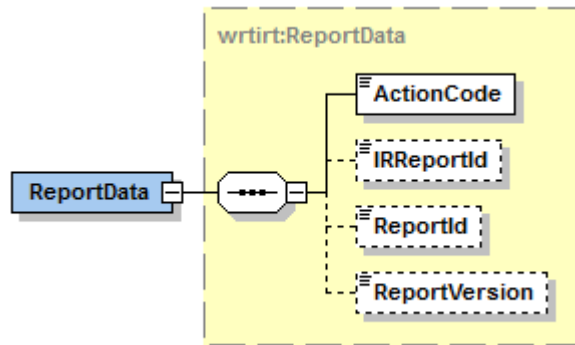

Data group details:

Data designation	Type	Allowed values	V/M	Processing rule
Service data (ReportData)	wrtirt:ReportData		M	There may be only one instance of a report in a record (the same record may not contain both a new and a replacement report, or several replacement reports, of the same report).
Action type (ActionCode)	xs:int	Codes: ActionCode	M	
Incomes Register report reference (IRReportId)	irct:Guid		V/M	Mandatory data, if the "Action type" is "Replacement report" and "Payer's report reference" has not been specified. This data must not be specified if the "Action type" is "New report".
Payer's report reference (ReportId)	irct:String40		V/M	Mandatory data in the following cases: <ul style="list-style-type: none"> • "Action type" is "New report". • "Action type" is "Replacement report" and the "Incomes Register report reference" data has not been specified. <p>The payer's report reference must uniquely identify all earnings payment reports of a specific payer (Payer).</p>



Data designation	Type	Allowed values	V/M	Processing rule
Report version number (ReportVersion)	xs:int		V	The version number must be a positive integer larger than zero. This data must not be specified if the "Action type" is "New report".



2.13 Income earner details (IncomeEarner)

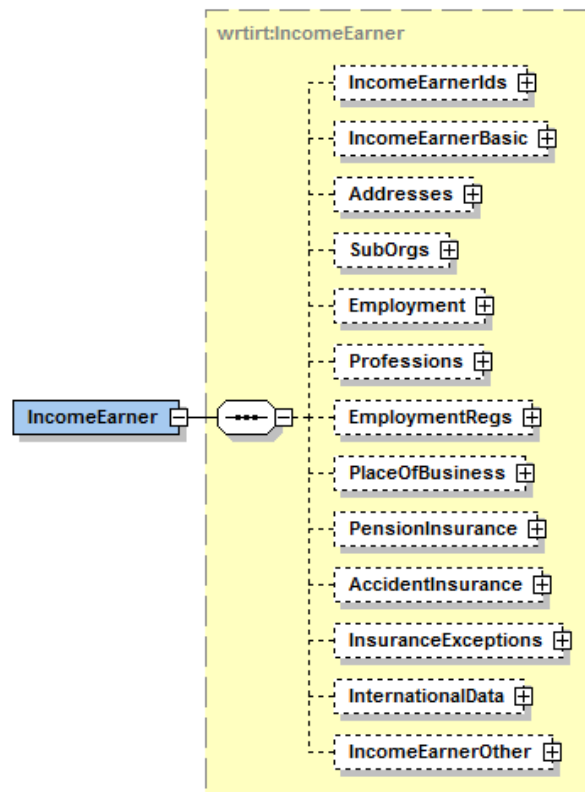

Data group details:

Data designation	Type	V/M
Income earner details (IncomeEarner)	wrtirt:IncomeEarner	M
Income earner identifiers (IncomeEarnerIds).	wrtirt:IncomeEarnerIds	V/M
Basic income earner details (IncomeEarnerBasic)	wrtirt:IncomeEarnerBasic	V/M
Income earner's addresses (Addresses)	wrtirt:Addresses	V/M
Income earner's suborganisations (SubOrgs)	wrtirt:Suborgs	V



Data designation	Type	V/M
Employment relationship data (Employment)	wrtirt:Employment	V/M
Occupation (Professions)	wrtirt:Professions	V/M
Employment registration (EmploymentRegs)	wrtirt:EmploymentRegs	V/M
Place of business (PlaceOfBusiness)	wrtirt:PlaceOfBusiness	V
Earnings-related pension insurance (PensionInsurance)	wrtirt:PensionInsurance	V/M
Occupational accident insurance (AccidentInsurance)	wrtirt:AccidentInsurance	V
Insurance exceptions (InsuranceExceptions)	wrtirt:InsuranceExceptions	V/M
International situations (InternationalData)	wrtirt:InternationalData	V
Other details (IncomeEarnerOther)	wrtirt:IncomeEarnerOther	V



2.14 Income earner identifiers (IncomeEarnerIds)

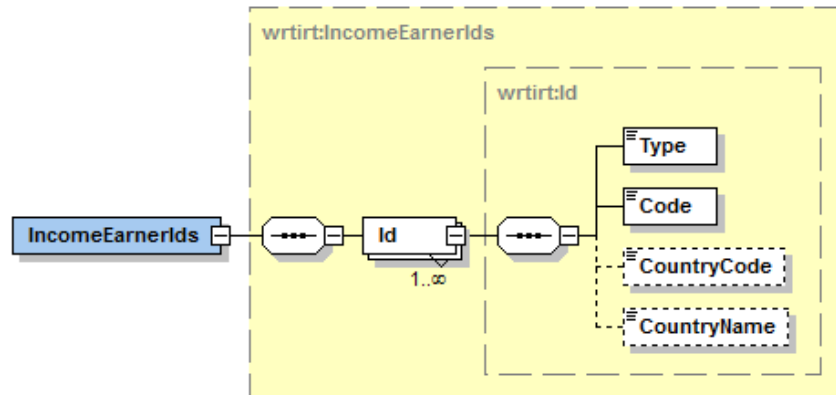

Data group details:

Data designation	Type	Allowed values	V/M	Processing rule
Income earner identifiers (IncomeEarnerIds).	wrtirt:IncomeEarnerIds		V/M	<p>Mandatory data group, if "The income earner does not have a customer ID" has not been specified.</p> <p>The data group must not be included, if "The income earner does not have a customer ID" has been specified.</p> <p>If the "Action type" is "Replacement report", the data should match that of the report's previous version.</p> <p>If multiple identifiers have been given in the data group, the identifier types cannot be the same. The same combination of identifier type and country code cannot be entered multiple times. There can only be one identifier type of "Finnish Personal Identification Number" or "Finnish Business ID" in the data group.</p>



Data designation	Type	Allowed values	V/M	Processing rule
Income earner identifier (Id)	wrtirt:Id		M	An income earner can have several identifiers. If the income earner is given both a Business ID and a Finnish Personal Identification Number, the identifiers must refer to the same customer.
Identifier type (Type)	xs:int	Codes: IdType	M	If the 'Reimbursement application data' data group is specified for a paid absence, and 1, 2 or 3 as the 'Payment data type' in the report, the income earner's identifier type must be 'Finnish Personal Identification Number'.
Identifier (Code)	irct:String30		M	If the "Identifier type" is "Business ID", the identifier must exist (according to information from the Business Information System (YTJ)). If the "Identifier type" is "Finnish Personal Identification Number", the identifier must exist (according to information from the Population Information System (VTJ)). If the "Identifier type" is "Finnish personal identity code", the type of additional income earner data cannot be "Organisation". If the "Identifier type" is other than "Business ID" or "Finnish Personal Identification Number", the identifier must not be Finnish personal identification number or Business ID. The data must not begin or end with non-printable whitespace characters, such as spaces. The data cannot contain non-printable whitespace characters, excluding space. The characters that are not to be used, are listed in chapter 1.2 Character set.
Country code (CountryCode)	irct:String2	A two-character code in accordance with the ISO 3166 country codes.	V/M	Mandatory data if "Identifier type" is other than "Business ID" or "Finnish Personal Identification Number". Country code "FI" must not be specified, if the specified "Identifier type" is other than "Business ID", "Finnish Personal Identification Number" or "Other identifier".



Data designation	Type	Allowed values	V/M	Processing rule
		If the country is unknown, the value "99" is entered.		If the "Identifier type" is set as "Finnish Personal Identification Number" or "Finnish Business ID" the country code can only be "FI".
Country name (CountryName)	irct:String70		V/M	Mandatory data if "Country code" is "99".



2.15 Basic income earner details (IncomeEarnerBasic)

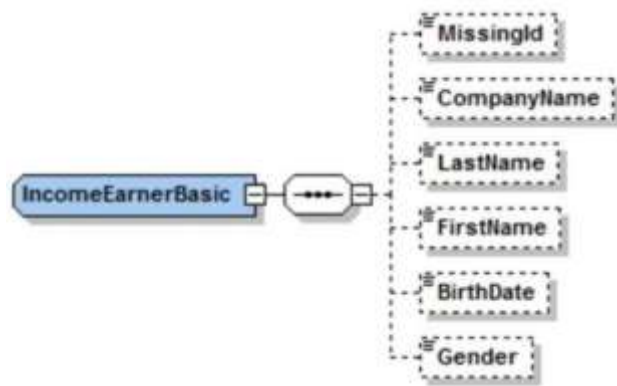

Data group details:

Data designation	Type	Allowed values	V/M	Processing rule
Basic income earner details (IncomeEarnerBasic)	wrtirt:IncomeEarnerBasic		V/M	Mandatory data group in the following cases: <ul style="list-style-type: none"> No identifiers where "Identifier type" is "Business ID" or "Finnish Personal Identification Number" have been specified in the "Income earner identifiers" data group.
The income earner does not have a customer ID (MissingId)	irct:true	"true"	V/M	Mandatory data if no identifiers have been specified for the income earner in the "Income earner identifiers" data group.
Company name (CompanyName)	irct:String200		V/M	Mandatory data in the following cases: <ul style="list-style-type: none"> No identifier where the "Identifier type" is "Business ID" or "Finnish Personal Identification Number" has been specified in the "Income earner identifiers" data group, and "Last name" and "First name" have not been specified. The value of "The income earner does not have a customer ID" is "true", and "Last name" and "First name" have not been specified.
Last name (LastName)	irct:String200		V/M	Mandatory data in the following cases: <ul style="list-style-type: none"> No identifier where the "Identifier type" is "Business ID" or "Finnish Personal Identification Number" has been



Data designation	Type	Allowed values	V/M	Processing rule
				<p>specified in the "Income earner identifiers" data group, and "Company name" has not been specified.</p> <ul style="list-style-type: none"> The value of "The income earner does not have a customer ID" is "true", and "Company name" has not been specified.
First name (FirstName)	irct:String100		V/M	Checked in the same way as "Last name".
Date of birth (BirthDate)	xs:date		V/M	<p>Mandatory data in the following cases:</p> <ul style="list-style-type: none"> No identifier where the "Identifier type" is "Finnish Personal Identification Number" has been specified in the "Income earner identifiers" data group, and "Last name" and "First name" have been specified. The value of "The income earner does not have a customer ID" is "true", and "Last name" and "First name" have been specified. <p>The date must not be later than the current date. The date must not be earlier than 1 January 1800.</p> <p>If the "Action type" is "Replacement report", the data should match that of the report's previous version.</p>
Gender (Gender)	xs:int	Codes: Gender	V/M	Mandatory data if no identifier where the "Identifier type" is "Finnish Personal Identification Number" has been specified in the "Income earner identifiers" data group, and "Last name" and "First name" have been specified.



2.16 Income earner's addresses (Addresses)

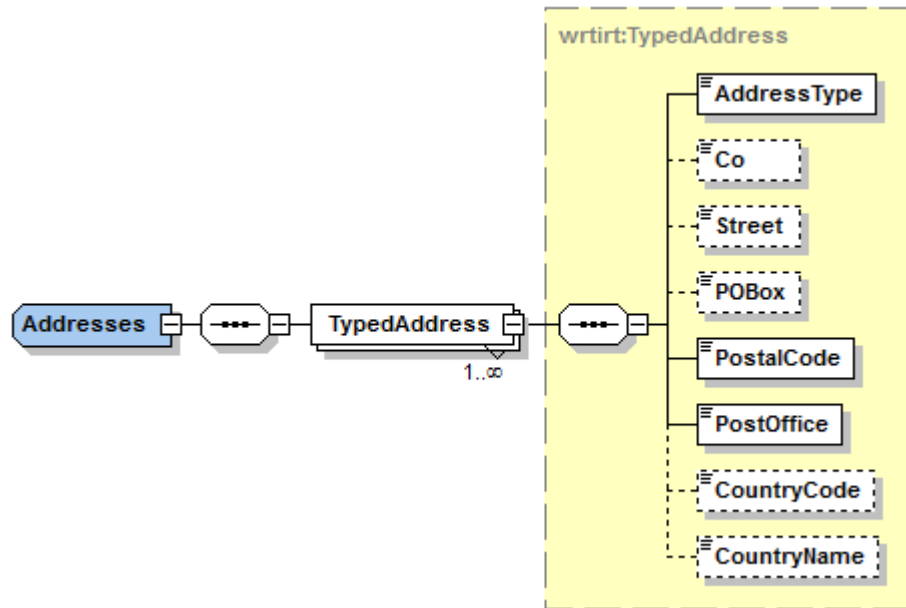

Data group details:

Data designation	Type	Allowed values	V/M	Processing rule
Income earner's addresses (Addresses)	wrtirt:Addresses		V/M	Mandatory data group in the following cases: <ul style="list-style-type: none"> No identifiers where "Identifier type" is "Business ID" or "Finnish Personal Identification Number" have been specified in the "Income earner identifiers" data group. The value of "The income earner does not have a customer ID" is "true". The value of "Non-resident taxpayer" is "true". In this case, at least the address in home country ("Address type" is "Address in home country") must be specified for the income earner.



Data designation	Type	Allowed values	V/M	Processing rule
Income earner's address (TypedAddress)	wrtirt:TypedAddresses		M	An income earner can have several addresses.
Address type (AddressType)	xs:int	Codes: AddressType	M	
c/o (Co)	irct:String70		V	
Street address (Street)	irct:String100		V/M	If this data group is included, either "Street address" or "P.O. Box" must be specified. Both must not be entered.
P.O. Box (POBox)	irct:String10		V/M	If this data group is included, either "Street address" or "P.O. Box" must be specified. Both must not be entered.
Postal code (PostalCode)	irct:String20		M	
City (PostOffice)	irct:String200		M	
Country code (CountryCode)	irct:String2	A two-character code in accordance with the ISO 3166 country codes. If the country is unknown, the value "99" is entered.	V/M	Mandatory data in the following cases: <ul style="list-style-type: none"> • No identifier where "Identifier type" is "Business ID" or "Finnish Personal Identification Number" has been specified in the "Income earner identifiers" data group. • The value of "The income earner does not have a customer ID" is "true". • The value of "Non-resident taxpayer" is "true".
Country name (CountryName)	irct:String70		V/M	Mandatory data if "Country code" is "99".



2.17 Income earner's suborganisations (SubOrgs)

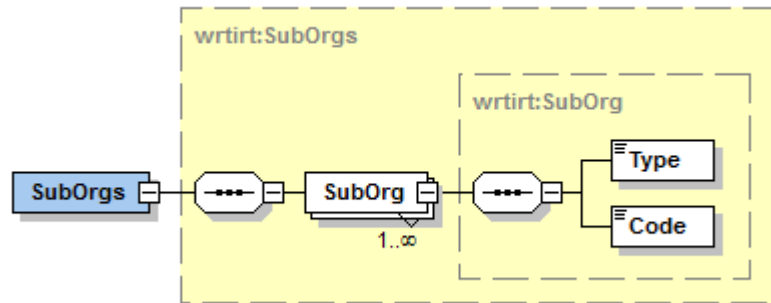

Data group details:

Data designation	Type	Allowed values	V/M	Processing rule
Income earner's suborganisations (SubOrgs)	wrtirt:SubOrgs		V	
Income earner's suborganisation (SubOrg)	wrtirt:SubOrg		M	An income earner can have several suborganisations.
Suborganisation's identifier type (Type)	xs:int	Codes: IncomeEarnerSubOrgType	M	
Suborganisation identifier (Code)	irct:String20		M	



2.18 Employment relationship data (Employment)

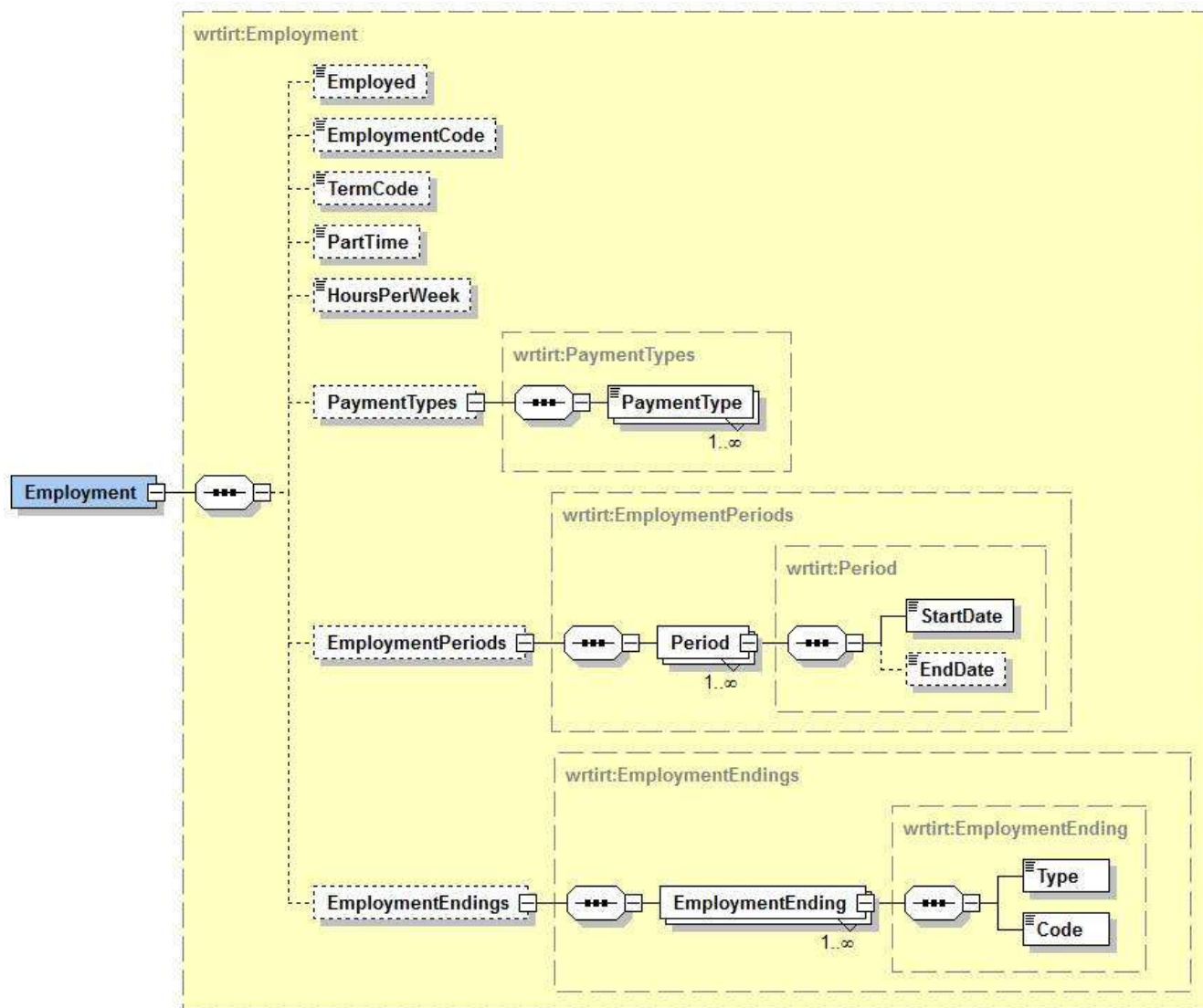

Data group details:

Data designation	Type	Allowed values	V/M	Processing rule
Employment relationship data (Employment)	wrtirt:Employment		V/M	
Employed (Employed)	irct:trueOrFalse		V	
Employment type (EmploymentCode)	xs:int	Codes: EmploymentCode	V/M	Mandatory data if a paid absence and the 'Reimbursement application data' data group for it are specified in the report, with 2 (Kela, family leave compensation) or 3 (Kela, compensation for annual leave costs) as the 'Payment data type'.
Duration of employment (TermCode)	xs:int	Codes: TermCode	V	
Part-time % (PartTime)	irct:decimal2		V	The value must be a non-negative decimal number with a maximum value of 100.00.
Regular agreed working hours per week (HoursPerWeek)	irct:decimal2		V	The value must be a non-negative decimal number with a maximum value of 168.00.
Forms of payment (PaymentTypes)	wrtirt:PaymentTypes		V/M	This data group is mandatory if a paid absence and the 'Reimbursement application data' data group for it are specified in the report, with 1, 2 or 3 as the 'Payment data type'.
Form of payment (PaymentType)	xs:int	Codes: PaymentType	M	An income earner can have several forms of payment. This data group is mandatory if a paid absence and the 'Reimbursement application data' data group for it are specified in the report, with 1, 2 or 3 as the 'Payment data type'. At least one of the following must then be specified as the form of payment: 1 (Monthly salary), 2 (Hourly rate) or 3 (Contract pay).
Employment period (EmploymentPeriods)	wrtirt:EmploymentPeriods		V/M	Mandatory data group, if "Pension provider code" is 20, 24, 25, 27, 29 or 30.



Data designation	Type	Allowed values	V/M	Processing rule
				This data group is mandatory if a paid absence and the 'Reimbursement application data' data group for it are specified in the report, with 1, 2 or 3 as the 'Payment data type'.
Time of employment (Period)	wrtirt:Period		M	An income earner can have several times of employment.
Start date (StartDate)	xs:date		M	The date must not be more than 45 days later than the current date. The date must not be earlier than 1 January 1800. If a paid absence and the 'Reimbursement application data' data group for it are specified in the report, with 1, 2 or 3 as the 'Payment data type', the 'Start date' of the period of paid absence cannot be earlier than the 'Start date' of the earliest period of employment specified in the report.
End date (EndDate)	xs:date		V/M	The date must not be earlier than the "Start date".
Termination of employment (EmploymentEndings)	wrtirt:Employment Endings		V/M	Mandatory data group, if "Time of employment" with an "End date" has been specified in the report, and the "Pension provider code" is 20, 24, 25, 27, 29 or 30.
Reason for the termination of employment (EmploymentEnding)	wrtirt:Employment Ending		M	An income earner can have several reasons for the termination of employment but only one value in accordance with the "Reason codes for termination of employment" data item. A reason for termination in accordance with the Keva codes reason codeset and a reason for termination in accordance with the Bank of Finland reason codeset cannot be given on the same report.
Reason codes for termination of employment (Type)	xs:int	Codes: EmploymentEndingT ype	M	If 'Earnings-related pension provider code' is 20, 24, 25, 29 or 30, the report must include one reason for termination in accordance with the 'Keva codes' reason codeset. If 'Earnings-related pension provider code' is 27, the report must include



Data designation	Type	Allowed values	V/M	Processing rule
				one reason for termination in accordance with the 'Bank of Finland codes' reason codeset. In addition, a report can always include a reason for termination in accordance with the 'Incomes Register codes' reason codeset.
Reason code for termination of employment (Code)	irct:String20		M	<p>If "Keva codes" are used for the reason codes, the codeset must include the combination ("Reason code for the termination of employment", "Pension provider code") and it must be valid on the date that is the value of "Payment date or other report date".</p> <p>If the reason codeset is other than 'Keva codes', it must include this data. If the codeset includes a validity period, the value must be valid on the date that is the value of "Payment date or other report date" in the specified codeset.</p>



2.19 Occupation (Professions)

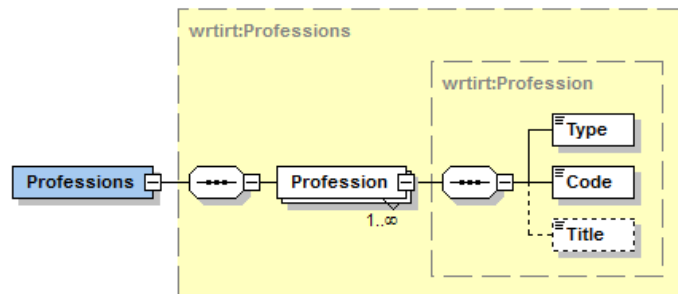

Data group details:

Data designation	Type	Allowed values	V/M	Processing rule
Occupation (Professions)	wrtirt:Professions		V/M	<p>The "Occupational class or title" data group must always be specified for an income earner, with the "Occupational class or title identifier" in accordance with "Statistics Finland's classification of occupations" included, except in the following situations:</p> <p>a) The report contains no income types that require specification of the "Occupational class or title" data group. This takes account of whether the income type is, by default, income subject to accident and occupational disease insurance (see the document, "Wages – Codes – Income types") and whether the income type in the report is exceptionally subject to accident and occupational disease insurance. In the report, the exceptions to the income type's default values are specified using the "Type of insurance information" and "Grounds for insurance contribution" entries. If "Type of insurance information" is "Subject to accident and occupational disease insurance contribution" and the corresponding "Grounds for insurance contribution" value</p>



Data designation	Type	Allowed values	V/M	Processing rule
				<p>is "true"/"false", the income type in the report is/is not income subject to accident and occupational disease insurance.</p> <p>b) The value of "Acts as a substitute payer" is "true".</p> <p>c) The report includes a "Type of exception to insurance" that is one of the following:</p> <ul style="list-style-type: none"> • No obligation to provide insurance (earnings-related pension, health, unemployment or accident and occupational disease insurance) • No obligation to provide insurance (accident and occupational disease insurance) • Not subject to Finnish social security (earnings-related pension, health, unemployment or accident and occupational disease insurance) • Not subject to Finnish social security (accident and occupational disease insurance) <p>d) The report only includes income types in which "Recovery" is "true".</p> <p>The "Occupational class or title" data group must always be specified for an income earner, with the "Occupational class or title identifier" in accordance with "Trafi's titles" included, if the "Pension provider code" is 34.*</p> <p>The "Occupational class or title" data group must always be specified for an income earner, with the "Occupational class or title identifier" in accordance with "Keva's titles" included, if the "Pension provider code" is 20, 24, 25, 29 or 30.*</p> <p>The "Occupational class or title" data group must always be specified for an income earner, with the "Occupational class</p>



Data designation	Type	Allowed values	V/M	Processing rule
				<p>or title identifier" in accordance with "Bank of Finland's titles" included, if the "Pension provider code" is 27.*</p> <p>* Exception: The "Occupational class or title" data group does not need to be specified, if "Type of exception to insurance" with one of the following values has been specified for the income earner:</p> <ul style="list-style-type: none"> • No obligation to provide insurance (earnings-related pension, health, unemployment or accident and occupational disease insurance) • No obligation to provide insurance (earnings-related pension insurance) • Not subject to Finnish social security (earnings-related pension, health, unemployment or accident and occupational disease insurance) • Not subject to Finnish social security (earnings-related pension insurance)
Occupational class or title (Profession)	wrtirt:Profession		M	An income earner can have several "Occupational class or title" entries but only one value in accordance with the "Type of occupational title or classification" data item.
Type of occupational title or classification (Type)	xs:int	Codes: ProfessionType	M	
Occupational class or title identifier (Code)	irct:String20		M	If "Type of occupational title or classification" is "Keva's titles" and the codeset requires the use of a specific "Registration grounds identifier" in connection with the specified "Occupational class or title identifier", the codeset must include the combination ("Occupational class or title identifier", "Registration grounds identifier", "Pension provider code") and it must be valid on the date in accordance with the "Payment date or other report date".



Data designation	Type	Allowed values	V/M	Processing rule
				If "Type of occupational title or classification" has some other value, it must be included in the specified titles. If the titles include a validity period, the value must be valid on the date that is the value of "Payment date or other report date" in the specified titles.
Title (free text) (Title)	irct:String200		V	



2.20 Employment registration (EmploymentRegs)

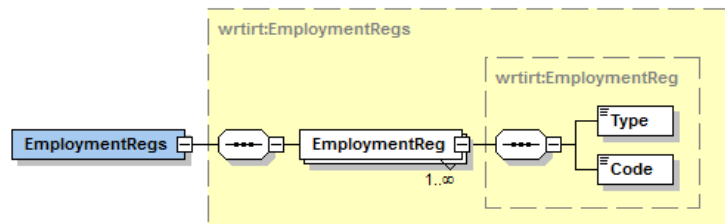

Data group details:

Data designation	Type	Allowed values	V/M	Processing rule
Employment registration (EmploymentRegs)	wrtirt:Employment Regs		V/M	The "Grounds for registration" data group must be specified, with the "Registration grounds identifier" in accordance with "Keva's grounds for registration" included, if the "Pension provider code" is 20, 24, 25, 29 or 30. The "Grounds for registration" data group must be specified, with the "Registration grounds identifier" in accordance with "Bank of Finland's grounds for registration" included, if the "Pension provider code" is 27.
Grounds for registration (EmploymentReg)	wrtirt:Employment Reg		M	An income earner can only have one ground for registration at a time.
Type of registration grounds (Type)	xs:int	Codes: EmploymentRegType	M	
Registration grounds identifier (Code)	irct:String20		M	If "Type of registration grounds" is "Keva's grounds for registration", the codeset must include the combination ("Registration grounds identifier", "Pension provider code"), and must be valid on the date that is the value of "Payment date or other report date". If "Type of registration grounds" is "Keva's grounds for registration", and the codeset requires the use of a specific "Occupational title or classification identifier" in connection



Data designation	Type	Allowed values	V/M	Processing rule
				<p>with the specified "Registration grounds identifier" value, the codeset must include the combination ("Registration grounds identifier", "Pension provider code") and must be valid on the date that is the value of "Payment date or other report date".</p> <p>If "Type of registration grounds" has some other value, it must be included in the specified codeset. If the codeset includes a validity period, the value must be valid on the date that is the value of "Payment date or other report date" in the specified codeset.</p>



2.21 Place of business (PlaceOfBusiness)

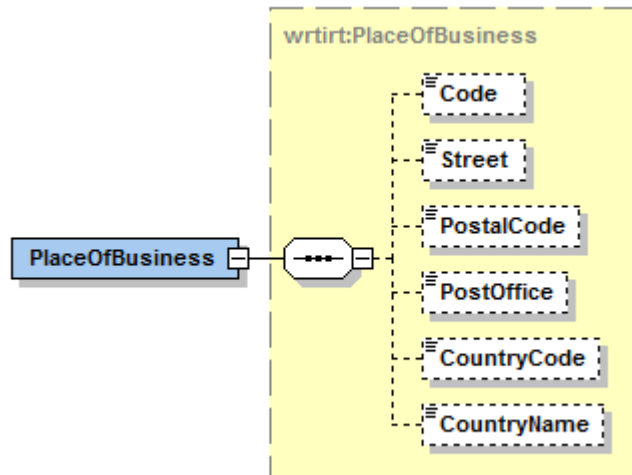

Data group details:

Data designation	Type	Allowed values	V/M	Processing rule
Income earner's place of business (PlaceOfBusiness)	wrtirt:PlaceOfBusiness		V	If this data group is included, either "Place of business code" or address details must be specified. If the address details are specified, they must include at least "Street address", "Postal code" and "City".
Place of business code (Code)	irct:String20		V/M	
Street address (Street)	irct:String100		V/M	
Postal code (PostalCode)	irct:String20		V/M	
City (PostOffice)	irct:String200		V/M	
Country code (CountryCode)	irct:String2	A two-character code in accordance with the ISO 3166 country codes.	V	



Data designation	Type	Allowed values	V/M	Processing rule
		If the country is unknown, the value "99" is entered.		
Country name (CountryName)	irct:String70		V/M	Mandatory data if "Country code" is "99".



2.22 Earnings-related pension insurance (PensionInsurance)

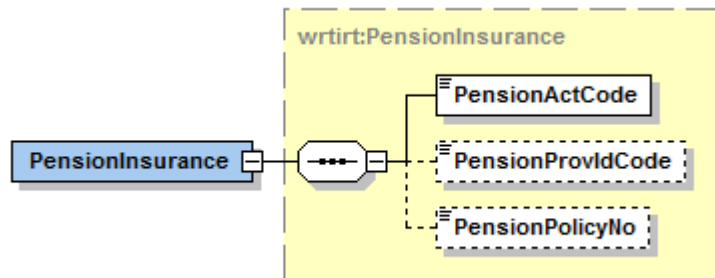

Data group details:

Data designation	Type	Allowed values	V/M	Processing rule
Earnings-related pension insurance (PensionInsurance)	wrtirt:PensionInsurance		V/M	<p>This data group is mandatory, except in the following situations:</p> <p>a) The report contains no income types that require specifying a value for "Earnings-related pension insurance information". This takes account of whether the income type is, by default, income subject to earnings-related pension insurance (see the document, "Wages – Codes – Income types") and also whether the income type in the report is exceptionally subject to earnings-related pension insurance. In the report, the exceptions to the income type's default values are specified using the "Type of insurance information" and "Grounds for insurance contribution" entries. If "Type of insurance information" is "Subject to earnings-related pension insurance contribution" and the corresponding "Grounds for insurance contribution" value is "true"/"false", the income type in the report is/is not income subject to earnings-related pension insurance.</p>



Data designation	Type	Allowed values	V/M	Processing rule
				<p>b) "Acts as a substitute payer" is "true".</p> <p>c) "Type of exception to insurance" is one of the following:</p> <ul style="list-style-type: none"> • No obligation to provide insurance (earnings-related pension, health, unemployment or accident and occupational disease insurance) • No obligation to provide insurance (earnings-related pension insurance) • Not subject to Finnish social security (earnings-related pension, health, unemployment or accident and occupational disease insurance) • Not subject to Finnish social security (earnings-related pension insurance) <p>d) The report only includes income types in which "Recovery" is "true".</p> <p><i>Exception:</i> Although the data group is not mandatory under items a to c, it must always be included if "Type of exception to insurance" is "Voluntary insurance in Finland (earnings-related pension insurance)".</p> <p><u>Employee's earnings-related pension insurance</u></p> <p>If "Employee's earnings-related pension insurance" is specified as the value of "Earnings-related pension insurance information", values must also be specified for "Pension provider code" and "Pension policy number".</p> <p><u>Pension insurance for farmers (MYEL)</u></p> <p>If "Pension insurance for farmers (MYEL)" is specified as the value of "Earnings-related pension insurance information",</p>



Data designation	Type	Allowed values	V/M	Processing rule
				<p>values must not be specified for "Pension provider code" or "Pension policy number".</p> <p>Pension insurance for the self-employed (YEL)</p> <p>If "Pension insurance for the self-employed (YEL)" is specified as the value of "Earnings-related pension insurance information", values must not be specified for "Pension provider code" or "Pension policy number".</p> <p>If the "Action type" is "Replacement report", the data should match that of the report's previous version.</p>
Earnings-related pension insurance information (PensionActionCode)	xs:int	Codes: PensionActionCode	M	
Pension provider code (PensionProvIdCode)	xs:int	Codes: PensionProvIdCode	V/M	The value of the data item must be the same as the first two/five characters of the value of the Pension policy number data item.
Pension policy number (PensionPolicyNo)	irct:PensionPolicyNo	Pension policy number codes of earnings-related pension providers	V/M	<p>The value must be a pension policy number conforming to the Pension policy number codes of earnings-related pension providers and must be valid on the "Date of payment or other report".</p> <p>If the pension policy number is a generic pension policy number for a temporary employer in accordance with the "Pension provider code" entry, one "Payer type" entry must be "Temporary employer (no TyEL insurance)" and the pension policy number must be valid on the day specified in the "Date of payment or other report" entry.</p>



2.23 Occupational accident insurance (AccidentInsurance)

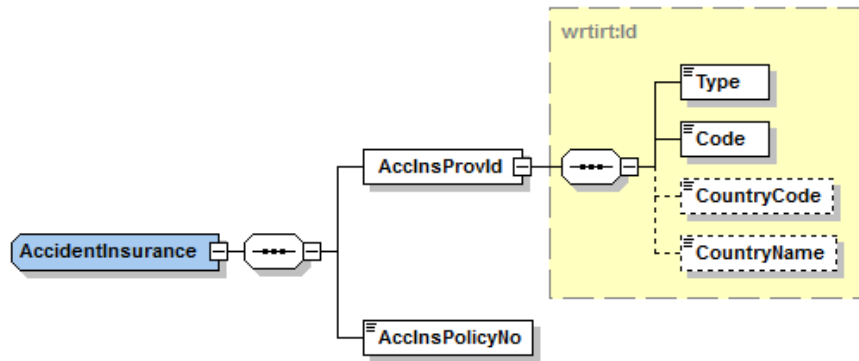

Data group details:

Data designation	Type	Allowed values	V/M	Processing rule
Occupational accident insurance (AccidentInsurance)	wrtirt:AccidentInsurance		V	If the "Action type" is "Replacement report", the data should match that of the report's previous version.
Occupational accident insurance company identifier (AccInsProvid)	wrtirt:Id		M	
Identifier type (Type)	xs:int	Codes: IdType	M	Type of identifier must not be a "Finnish Personal Identity code" or a "Foreign personal identity code".
Identifier (Code)	irct:String30		M	If the "Identifier type" is "Business ID", the identifier must exist (according to information from the Business Information System (YTJ)). If the "Identifier type" is other than "Business ID" or "Finnish Personal Identification Number", the identifier must not be Finnish personal identification number or Business ID. The data must not begin or end with non-printable whitespace characters, such as spaces. The data cannot contain non-printable whitespace characters, excluding space. The



Data designation	Type	Allowed values	V/M	Processing rule
				characters that are not to be used, are listed in chapter 1.2 Character set.
Country code (CountryCode)	irct:String2	A two-character code in accordance with the ISO 3166 country codes. If the country is unknown, the value "99" is entered.	V/M	Mandatory data if "Identifier type" is other than "Business ID" or "Finnish Personal Identification Number". Country code "FI" must not be specified, if the specified "Identifier type" is other than "Business ID", "Finnish Personal Identification Number" or "Other identifier". If the "Identifier type" is set as "Finnish Personal Identification Number" or "Finnish Business ID" the country code can only be "FI".
Country name (CountryName)	irct:String70		V/M	Mandatory data if "Country code" is "99".
Occupational accident insurance policy number (AccInsPolicyNo)	irct:String20		M	The data must not contain non-printable whitespace characters, such as spaces.



2.24 Insurance exceptions (InsuranceExceptions)

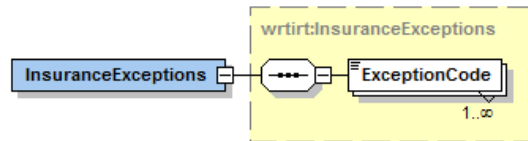

Data group details:

Data designation	Type	Allowed values	V/M	Processing rule
Insurance exceptions (InsuranceExceptions)	wrtirt:InsuranceExc ptions		V/M	<p>If the Type of exception to insurance = 11 (Voluntary earnings-related pension) has been specified for the income earner, the values 1, 3, 6 or 7 should not be specified for the Type of exception to insurance in the same report.</p> <p>If the "Action type" is "Replacement report", the data should match that of the report's previous version.</p>
Type of exception to insurance (ExceptionCode)	xs:int	Codes: InsuranceExceptionC ode	M	<p>An income earner can have several "Type of exception to insurance" entries.</p> <p>If the 'Earnings-related pension insurance information' is 'Pension insurance for farmers (MYEL)' or 'Pension insurance for the self-employed (YEL)', the following 'Type of exception to insurance' information must be specified in the report:</p> <ul style="list-style-type: none"> • No obligation to provide insurance (earnings-related pension insurance) • No obligation to provide insurance (accident and occupational disease insurance) • No obligation to provide insurance (unemployment insurance).



Data designation	Type	Allowed values	V/M	Processing rule
				<p>If the type of additional income earner data (IncomeEarnerType) is 'Self-employed person, no obligation to provide YEL or MYEL insurance', the following 'Type of exception to insurance' data must be specified on the report:</p> <ul style="list-style-type: none"> • No obligation to provide insurance (earnings-related pension insurance) • No obligation to provide insurance (accident and occupational disease insurance) • No obligation to provide insurance (unemployment insurance) • No obligation to provide insurance (health insurance) <p>OR</p> <ul style="list-style-type: none"> • No obligation to provide insurance (earnings-related pension, health, unemployment or accident and occupational disease insurance).



2.25 International situations (InternationalData)

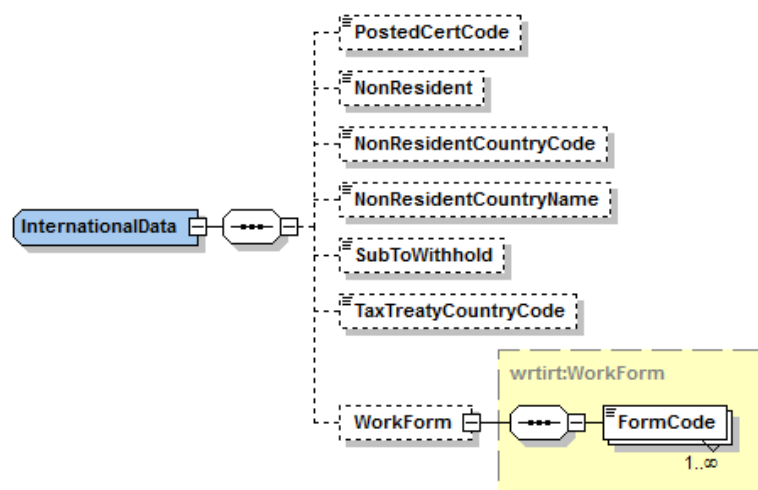

Data group details:

Data designation	Type	Allowed values	V/M	Processing rule
International situations (InternationalData)	wrtirt:InternationalData		V	
Social security certificate (PostedCertCode)	xs:int	Codes: PostedCertCode	V	
Non-resident taxpayer (NonResident)	irct:true	"true"	V/M	If income type 412 or 362 is specified in the report, the value of the 'Non-resident taxpayer' data item must be 'true'.
Country code of country of residence (NonResidentCountryCode)	irct:String2	A two-character code in accordance with the ISO 3166 country codes. If the country is unknown, the value "99" is entered.	V/M	Mandatory data, if "Non-resident taxpayer" is "true".



Data designation	Type	Allowed values	V/M	Processing rule
Name of country of residence (NonResidentCountryName)	irct:String70		V/M	Mandatory data if "Country code" is "99".
Income subject to withholding (SubToWithhold)	irct:true	"true"	V	
Tax-treaty country code (TaxTreatyCountryCode)	irct:String2	Codes: TaxTreatyCountryCode	V/M	Mandatory data if the Type of additional income earner data (IncomeEarnerType) = "Income earner did not stay longer than 183 days in Finland during the Tax-Treaty-defined sojourn period". This data can only be specified if the Type of additional income earner data is the above-mentioned value. The value must be valid on the date specified in the data item "Payment date or other report date".
Forms for work abroad (WorkForm)	wrtirt:WorkForm		V	
Form type (FormCode)	xs:int	Codes: FormCode	M	Several form types can be specified for the income earner.



2.26 Other details (IncomeEarnerOther)

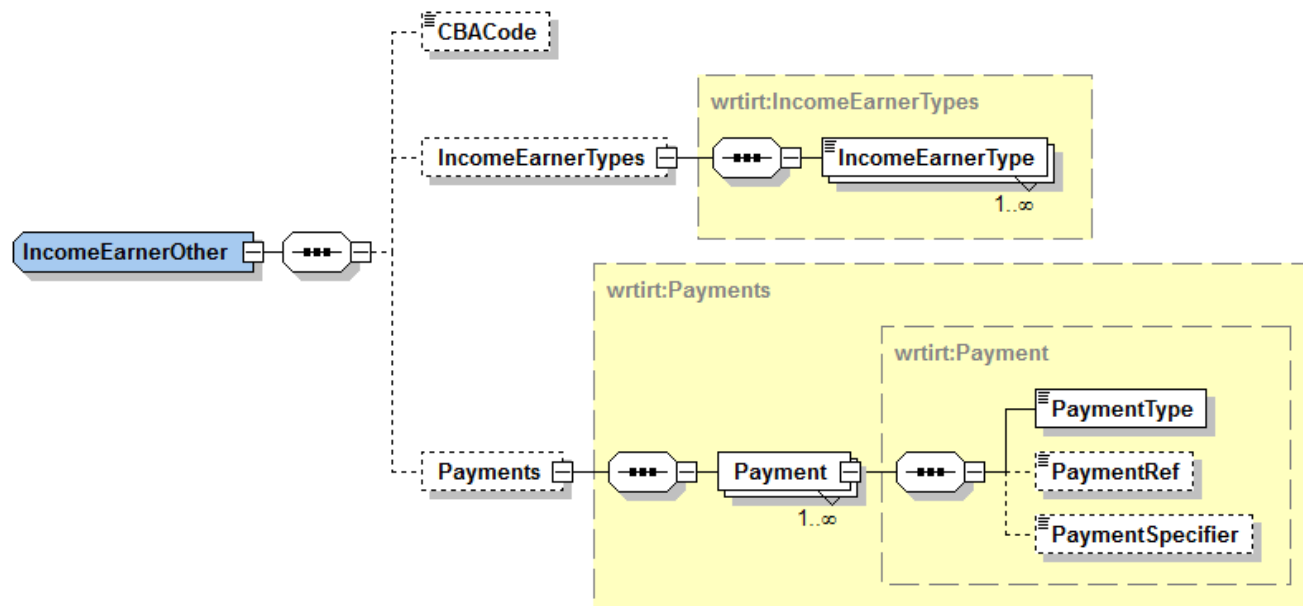

Data group details:

Data designation	Type	Allowed values	V/M	Processing rule
Other details (IncomeEarnerOther)	wrtirt:IncomeEarnerOther		V	
Applicable collective agreement (CBACode)	xs:int	Codes: CBACode	V	The value must be valid on the date specified in the data item "Payment date or other report date".
Additional income earner details (IncomeEarnerTypes)	wrtirt:IncomeEarnerTypes		V	There may be several additional income earner data entries.
Type of additional income earner data (IncomeEarnerType)	xs:int	Codes: IncomeEarnerType	M	If the "Action type" is "Replacement report" and the "Type of additional income earner data" is "Athlete" or "Organisation", the data should match that of the report's previous version. If the type of additional income earner information (IncomeEarnerType) is 'Employer pays taxes on behalf of the



Data designation	Type	Allowed values	V/M	Processing rule
				<p>employee ('Net-of-tax' employment contract)', 'Foreign employer' must be specified as the 'Payer type' data. If "Type of occupational title or classification" is 'Statistics Finland's classification of occupations (TK10)' and "Occupational class or title identifier" is '34210' (Athletes), the Type of additional income earner must be set as 'Athlete'.</p> <p>The same earnings payment report can only have one of the following Type of additional income earner data values:</p> <ul style="list-style-type: none"> • Leased employee living abroad • Leased employee living abroad, working on board a Finnish aircraft • Leased employee living abroad, working on board a Finnish ship • Income earner did not stay longer than 183 days in Finland during the Tax-Treaty-defined sojourn period <p>Mandatory data Group if the report contains a "Form type" for "Employee leasing notice". In this case, one of the following Type of additional income earner data values must be provided:</p> <ul style="list-style-type: none"> • Leased employee living abroad • Leased employee living abroad, working on board a Finnish aircraft • Leased employee living abroad, working on board a Finnish ship
Payment data (Payments)	wrtirt:Payments		V	There can be several payment data entries.
Payment data (Payment)	wrtirt:Payment		M	A report can only have one value in accordance with the "Payment data type" data item. For example: The report may only include one "Payment data", the "Payment data type" of which is "Earnings-related pension provider".



Data designation	Type	Allowed values	V/M	Processing rule
Payment data type (PaymentType)	xs:int	code set RefPaymentType	M	
Payment's reference number (PaymentRef)	irct:String50		V/M	Mandatory data, if "Payment data type" is "Earnings-related pension provider".
Payment specifier (PaymentSpecifier)	irct:String200		V	



2.27 Income types (Transactions)

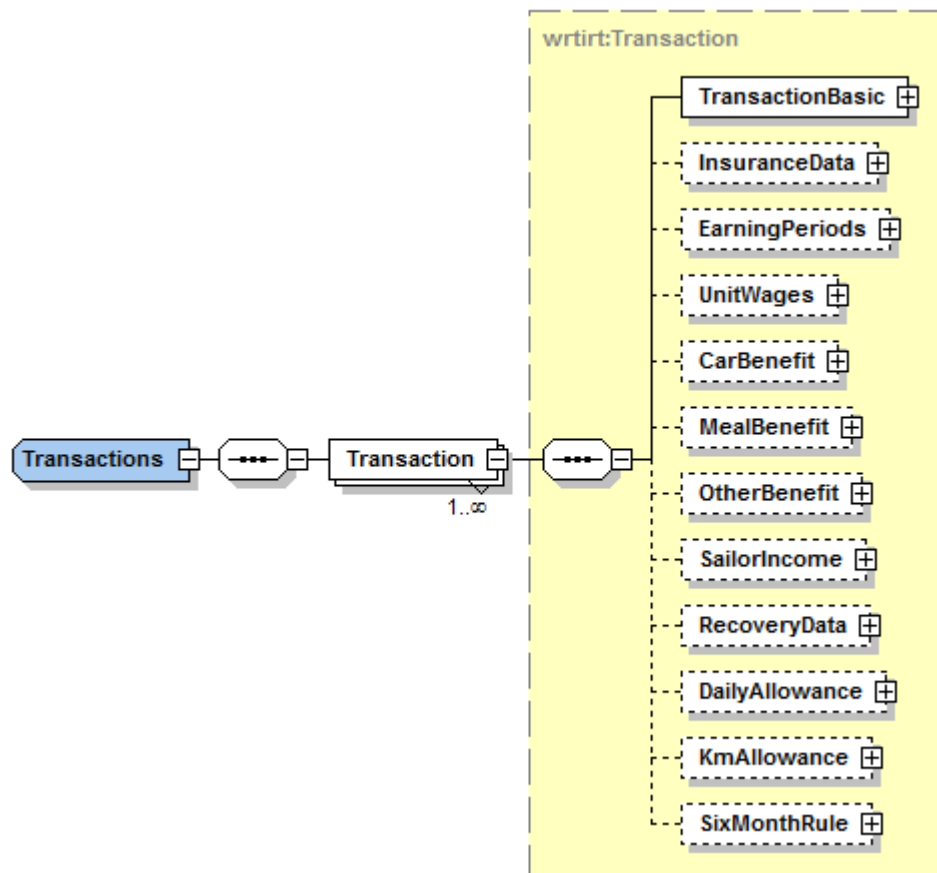

Data group details:

Data designation	Type	V/M	
Income types (Transactions)	wrtirt:Transactions	V	<p>Reporting method 2 income types may not be used in connection with reporting method 1. Separately reported income types can be used with both reporting methods.</p> <p>Income types reported using reporting method 1, reporting method 2, and separately are described in the documents, "Descriptions of income types and items deducted from income" and "Wages – Codes – Income types".</p> <p>If any of the income types of reporting method 1 (102, 103, 104, 105, 106) has been included in a report, at least the "Total wages" income type (101) must be included in the report.</p> <p>If the "Total wages subject to social insurance contributions" (103) income type has been included in a report, income types 102, 104, 105 and 106 must not be included in the report.</p> <p>The "Total wages" income type (101):</p> <ul style="list-style-type: none"> Income type 101 can be submitted in a report only once, in such a manner that it is not unjust enrichment or recovery. Income type 101 can be submitted in a report only once, in such a manner that it is unjust enrichment.



Data designation	Type	V/M	
			<ul style="list-style-type: none"> Income type 101 can be submitted in a report several times in such a manner that it is recovery. In this case, the original payment periods (OrigPaymentPeriod) of the income types must not be the same.
Income type details (Transaction)	wrtirt:Transaction	M	An income earner can have several income types.
General income type details (TransactionBasic)	wrtirt:TransactionBasic	M	
Insurance information (InsuranceData)	wrtirt:InsuranceData	V	
Earnings periods (EarningPeriods)	wrtirt:EarningPeriods	V	
Unit of the wages (UnitWages)	wrtirt:UnitWages	V	
Car benefit (CarBenefit)	wrtirt:CarBenefit	V/M	
Meal benefit (MealBenefit)	wrtirt:MealBenefit	V	
Other fringe benefit (Otherbenefit)	wrtirt:OtherBenefit	V/M	
Seafarer's income (SailorIncome)	wrtirt:SailorIncome	V	
Additional details on recovery (RecoveryData)	wrtirt:RecoveryData	V/M	
Daily allowance (DailyAllowance)	wrtirt:DailyAllowance	V/M	
Kilometre allowance (tax-exempt) (KmAllowance)	wrtirt:KmAllowance	V	
Six-month rule (SixMonthRule)	wrtirt:SixMonthRule	V	



2.28 General details on the income type (TransactionBasic)

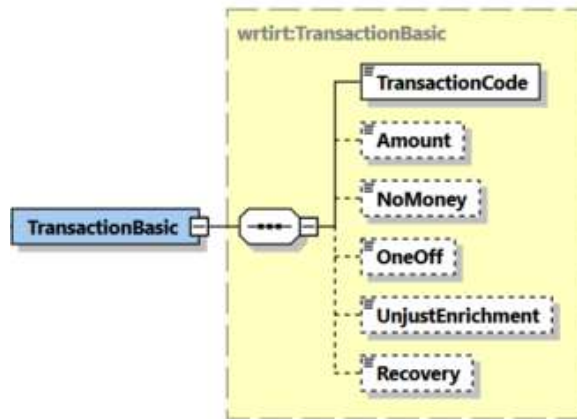

Data group details:

Data designation	Type	Allowed values	V/M	Processing rule
General income type details (TransactionBasic)	wrtirt:TransactionBasic		M	
Income type code (TransactionCode)	xs:int	Codes: TransactionCode	M	<p>If the 'Income type code' is 412 or 362, the value of the 'Non-resident taxpayer' data item must be 'true'.</p> <p>If the 'Income type code' is 334 (Meal benefit) and the value of the 'Reimbursement for a meal benefit corresponds to taxable value (TaxValue)' is 'true', and none of the income types 301, 302, 317 or 330 have been specified in the report, the income type 407 must not be specified.</p> <p>Income type 407 must not be specified if none of the following income types have been specified in the report: 301, 302, 317, 330 or 334.</p>



Data designation	Type	Allowed values	V/M	Processing rule
				<p>Income type 419 must not be specified if none of the following income types have been specified in the report: 101–106, 201–207, 209-227, 230–239, 308, 315, 316, 320, 326, 336, 339, 351, 353–355, 359, 366, 367, 368.</p> <p>Income type 402 (Withholding tax) must not be specified if income type 362 (Royalty paid to a non-resident taxpayer) has been specified on the report.</p> <p>Income type 402 (Withholding tax) must not be specified if the type of additional income earner information (IncomeEarnerType) is 'Key employee'.</p> <p>If the "Income type code" is 369, the earnings-related pension provider code (PensionProvIdCode) must be 20, 24,25, 27, 29 or 30.</p> <p>If the "Income type code" is 321-325, a Type of exception to insurance corresponding the chosen income type cannot be given on the same report:</p> <ul style="list-style-type: none"> Income type 321 and Type of exception to insurance code No obligation to provide insurance (earnings-related pension, health, unemployment or accident and occupational disease insurance), No obligation to provide insurance (earnings-related pension insurance), No obligation to provide insurance (unemployment insurance), No obligation to provide insurance (accident and occupational disease insurance) or No obligation to provide insurance (health insurance) cannot be given on the same report.



Data designation	Type	Allowed values	V/M	Processing rule
				<ul style="list-style-type: none"> Income type 322 and Type of exception to insurance code No obligation to provide insurance (earnings-related pension, health, unemployment or accident and occupational disease insurance), No obligation to provide insurance (earnings-related pension insurance) cannot be given on the same report. Income Type 323 and Type of exception to insurance code No obligation to provide insurance (earnings-related pension, health, unemployment or accident and occupational disease insurance), No obligation to provide insurance (unemployment insurance) cannot be given on the same report. Income Type 324 and Type of exception to insurance code No obligation to provide insurance (earnings-related pension, health, unemployment or accident and occupational disease insurance), No obligation to provide insurance (accident and occupational disease insurance) cannot be given on the same report. Income Type 325 and Type of exception to insurance code No obligation to provide insurance (earnings-related pension, health, unemployment or accident and occupational disease insurance), No obligation to provide insurance (health insurance) cannot be given on the same report.
Amount (Amount)	irct:decimal2		V/M	<p>If 'Income type code' is 102, 103, 104, 105 or 106, the value must not be greater than the amount reported for income type 101.</p> <p>The Wages – Codes – Income types document lists the income types for which a negative Amount can be specified. A negative Amount must not be specified for other income types.</p>



Data designation	Type	Allowed values	V/M	Processing rule
				<p>If the 'Recovery (Recovery)' data specified even for one income type on the report is 'true', a negative 'Amount' data must not be specified for income type 402 (Withholding tax) or 404 (Tax at source) on the report.</p> <p>If the value of the 'Reimbursement for a meal benefit corresponds to taxable value (TaxValue)' data item specified for income type 334 is 'true', the amount is not mandatory.</p> <p>If 'Income type code' is 401 (Compensation collected for car benefit), the amount must not be greater than the amount reported using income type 304 (Car benefit).</p> <p>If 'Income type code' is 407 (Reimbursement collected for other fringe benefits), the amount must not be greater than the total amount reported using the following income types: 301 (Housing benefit), 302 (Interest benefit for a housing loan), 317 (Other fringe benefit), 330 (Telephone benefit) and 334 (Meal benefit).</p> <p>If 'Income type code' is 419 (Deduction before withholding), the amount must not be greater than the total amount reported using the following income types: 101–106, 201–207, 209–227, 230–239, 308, 315, 316, 320, 326, 336, 339, 351, 353–355, 359, 366, 367, 368.</p> <p>The following processing rule pertains to income types whose 'Income type code' is 401, 407 or 419: If several items deducted from income are reported using the same code, their total amount may not be higher than the total amount reported using the income types listed in the processing rule for the income type in question.</p>



Data designation	Type	Allowed values	V/M	Processing rule
Payment other than money (NoMoney)	irct:true	"true"	V	
One-off remuneration (OneOff)	irct:true	"true"	V	
Unjust enrichment (UnjustEnrichment)	irct:true	"true"	V	The Wages – Codes – Income types document lists the income types for which the 'Unjust enrichment' data item must not be specified.
Recovery (Recovery)	irct:true	"true"	V	The Wages – Codes – Income types document lists the income types for which the 'Recovery' data item must not be specified.

2.29 Insurance information (InsuranceData)

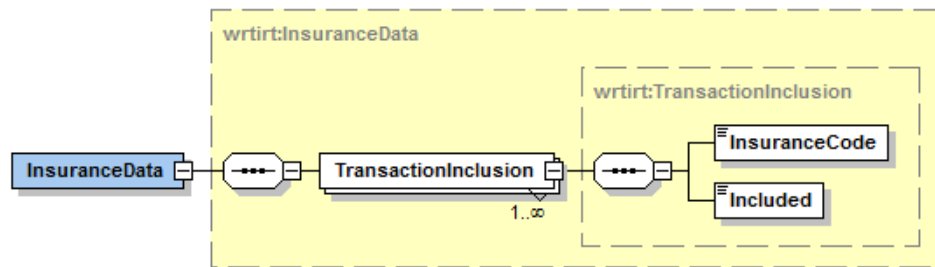

Data group details:

Data designation	Type	Allowed values	V/M	Processing rule
Insurance information (InsuranceData)	wrtirt:InsuranceData		V	<p>This data group can only be specified for the income types for which it is allowed (see the documents, "Descriptions of income types and items deducted from income" and "Wages – Codes – Income types").</p> <p>Rules A-E for 100-series income types described below must be in effect for the following income type groups, separately for each group:</p>



Data designation	Type	Allowed values	V/M	Processing rule
				<ul style="list-style-type: none"> • 100-series income types that are not unjust enrichment or recovery. • 100-series income types that are unjust enrichment. • 100-series income types that are recovery and that have the same Original payment period (OrigPaymentPeriod). <p>A) If the income type is 101 and income type 102 has also been submitted in the report, the following data must be specified in the Insurance information data group: Type of insurance information (InsuranceCode) = 1 or 2 Grounds for insurance contribution (Included) = false</p> <p>B) If the income type is 101 and income type 103 has also been submitted in the report, the following data must be specified in the Insurance information data group: Insurance information type (InsuranceCode) = 1 Grounds for insurance contribution (Included) = false</p> <p>C) If the income type is 101 and income type 104 has also been submitted in the report, the following data must be specified in the Insurance information data group: Type of insurance information (InsuranceCode) = 1 or 3 Grounds for insurance contribution (Included) = false</p> <p>D) If the income type is 101 and income type 105 has also been submitted in the report, the following data must be specified in the Insurance information data group:</p>



Data designation	Type	Allowed values	V/M	Processing rule
				Type of insurance information (InsuranceCode) = 1 or 5 Grounds for insurance contribution (Included) = false E) If the income type is 101 and income type 106 has also been submitted in the report, the following data must be specified in the Insurance information data group: Type of insurance information (InsuranceCode) = 1 or 6 Grounds for insurance contribution (Included) = false
Insurance information (TransactionInclusion)	wrtirt:TransactionInclusion		M	There may be several insurance information entries. However, an income type can have only one Insurance information conforming to the data item Insurance information type (for example: only one Insurance information where the Insurance information type is 1 can be specified for one and the same income type). If Insurance information where the Insurance information type is 1 is specified for an income type, then Insurance information where the Insurance information type is 2, 3, 5 or 6 cannot be specified for the same income type.
Insurance information type (InsuranceCode)	xs:int	Codes: InsuranceCode	M	
Grounds for insurance contribution (Included)	irct:trueOrFalse		M	



2.30 Earnings periods (EarningPeriods)

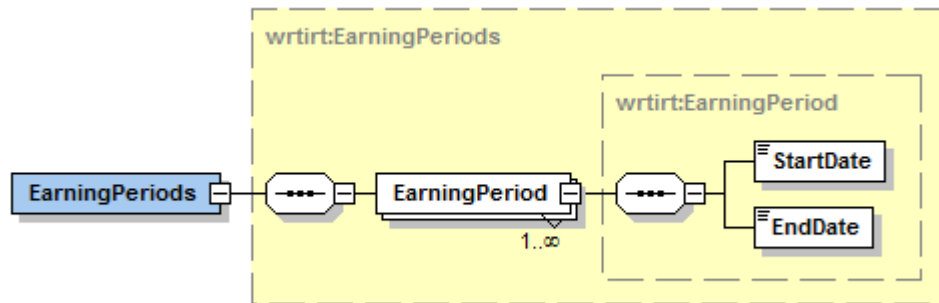

Data group details:

Data designation	Type	Allowed values	V/M	Processing rule
Earnings periods (EarningPeriods)	wrtirt:EarningPeriods		V	
Earnings period (EarningPeriod)	wrtirt:EarningPeriod		M	There may be several earnings periods.
Start date (StartDate)	xs:date		M	The date must not be earlier than 1 January 1800.
End date (EndDate)	xs:date		M	The date must not be earlier than the "Start date".



2.31 Unit of the wages (UnitWages)

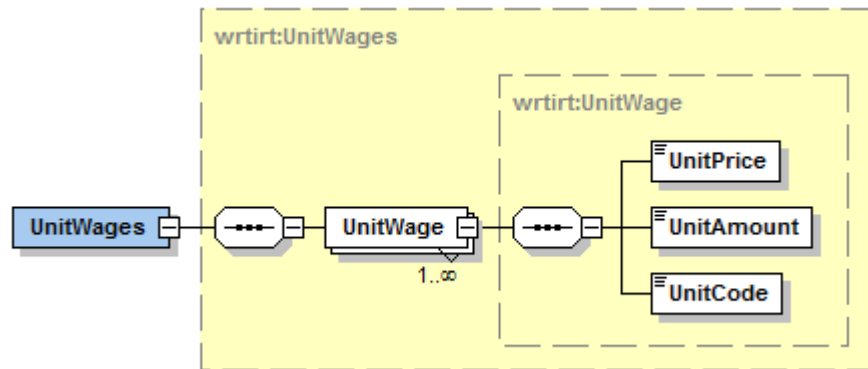

Data group details:

Data designation	Type	Allowed values	V/M	Processing rule
Unit of the wages (UnitWages)	wrtirt:UnitWages		V	
Unit wage (UnitWage)	wrtirt:UnitWage		M	There may be several unit wages.
Unit price (UnitPrice)	irct:decimal2		M	The value must be non-negative.
Number of units (UnitAmount)	irct:decimal2		M	The value must be non-negative.
Unit (UnitCode)	xs:int	Codes: WageUnitCode	M	



2.32 Car benefit (CarBenefit)

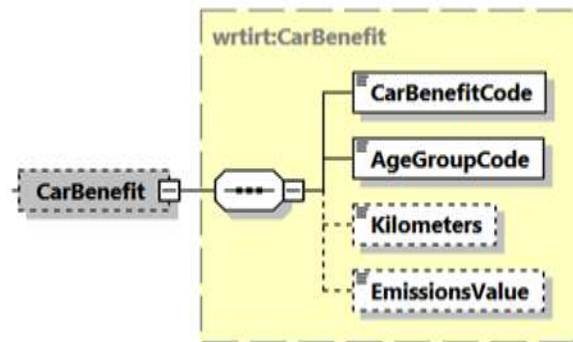

Data group details:

Data designation	Type	Allowed values	V/M	Processing rule
Car benefit (CarBenefit)	wrtirt:CarBenefit		V/M	Mandatory data group, if the income type is "Car benefit". This data group may not be used with other income types.
Car benefit type (CarBenefitCode)	xs:int	Codes: CarBenefitCode	M	
Car age group (AgeGroupCode)	xs:int	Codes: AgeGroupCode	M	
Odometer reading (Kilometers)	xs:int		V	The value must be greater than or equal to 0.
Car emissions value (EmissionsValue)	irct:decimal2		V	If the Payment date or other reporting date is in 2022-2025, the car emissions value must be greater than or equal to 0, and smaller than or equal to 100. If Payment date or other reporting date is in 2026-2029, the car emissions value must be 0. If Payment date or other reporting date is in 2019-2022 or after 2029, the car emissions value cannot be reported.



2.33 Meal benefit (MealBenefit)

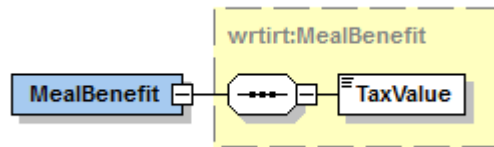

Data group details:

Data designation	Type	Allowed values	V/M	Processing rule
Meal benefit (MealBenefit)	wrtirt:MealBenefit		V	The data group may only be specified for the “Meal benefit” income type.
Reimbursement for a meal benefit corresponds to taxable value (TaxValue)	irct:true	"true"	M	



2.34 Other fringe benefit (Otherbenefit)

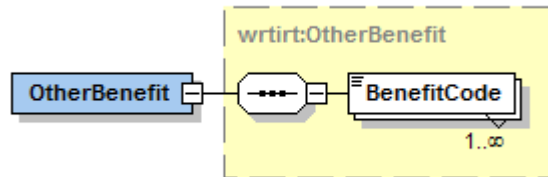

Data group details:

Data designation	Type	Allowed values	V/M	Processing rule
Other fringe benefit (Otherbenefit)	wrtirt:OtherBenefit		V/M	Mandatory data group, if the income type is "Other fringe benefit". This data group may only be provided if the income type is "Other fringe benefit".
Benefit type (BenefitCode)	xs:int	Codes: BenefitCode	M	<p>An income type can have several "Benefit type" entries.</p> <p>If the "Benefit type" is "Accommodation benefit", the "Accommodation benefit" income type may not be included in the report.</p> <p>If the "Benefit type" is "Telephone benefit", the "Telephone benefit" income type may not be included in the report.</p> <p>If the "Benefit type" is "Meal benefit", the "Meal benefit" income type may not be included in the report.</p>



2.35 Seafarer's income (SailorIncome)

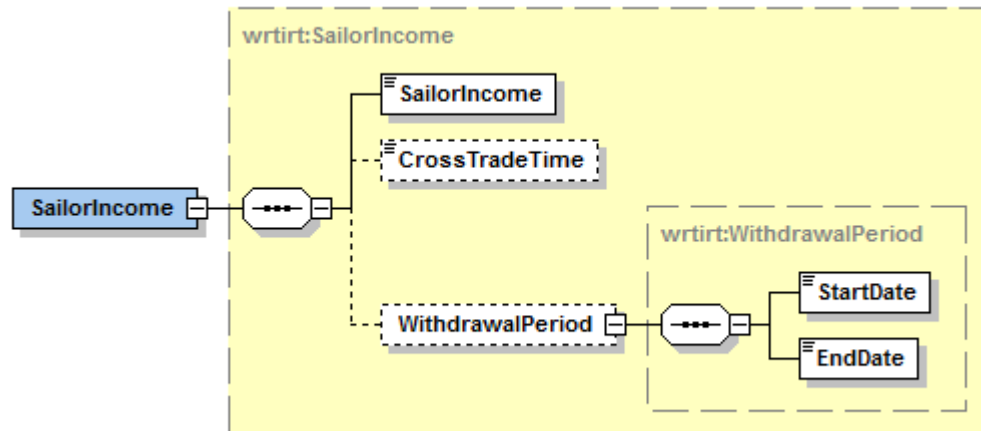

Data group details:

Data designation	Type	Allowed values	V/M	Processing rule
Seafarer's income (SailorIncome)	wrtirt:SailorIncome		V	
Payment is seafarer's income (SailorIncome)	irct:true	"true"	M	
Time of cross trade (CrossTradeTime)	xs:int	1 - 12	V	
Withdrawal period (WithdrawalPeriod)	wrtirt:WithdrawalPeriod		V	
Start date (StartDate)	xs:date		M	The date must not be earlier than 1 January 1800.
End date (EndDate)	xs:date		M	The date must not be earlier than the "Start date".



2.36 Additional details on recovery (RecoveryData)

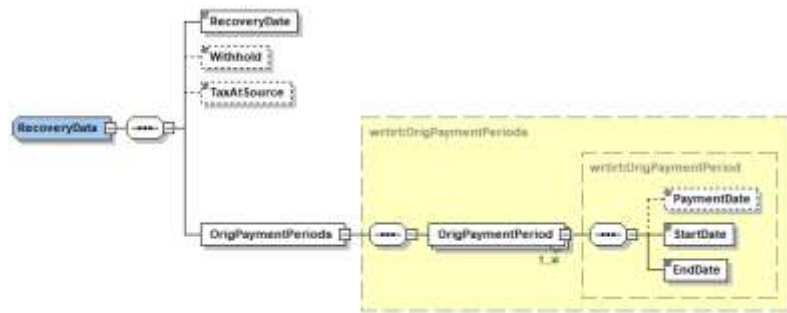

Data group details:

Data designation	Type	Allowed values	V/M	Processing rule
Additional details on recovery (RecoveryData)	wrtirt:RecoveryData		V/M	Mandatory data group, if "Recovery" is "true". This data group may only be included if "Recovery" is "true".
Recovery date (RecoveryDate)	xs:date		M	The data cannot be earlier than 1 January 2019. The data cannot be later than 'Payment date or other reporting date (PaymentDate)'.
Withholding from the recovered amount (Withhold)	irct:decimal2		V	
Tax at source from the recovered amount (TaxAtSource)	irct:decimal2		V	
Original payment periods (OrigPaymentPeriods)	wrtirt:OrigPaymentPeriods		M	
Original payment period (OrigPaymentPeriod)	wrtirt:OrigPaymentPeriod		M	There may be several original payment periods. The income type code for a recovery must be valid partially or completely during all the original payment periods or dates of payment.
Payment date (PaymentDate)	xs:date		V	The date must not be earlier than 1 January 1800. The date must not be later than the "Recovery date" (RecoveryDate).



Data designation	Type	Allowed values	V/M	Processing rule
Start date (StartDate)	xs:date		M	The date must not be earlier than 1 January 1800. The date must not be later than the "Recovery date" (RecoveryDate).
End date (EndDate)	xs:date		M	The "End date" may not be earlier than the "Start date":

2.37 Daily allowance (DailyAllowance)

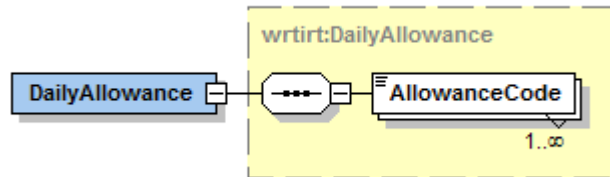

Data group details:

Data designation	Type	Allowed values	V/M	Processing rule
Daily allowance (DailyAllowance)	wrtirt:DailyAllowance		V/M	Mandatory data group, if the income type is "Daily allowance". This data group may be specified only for the "Daily allowance" income type.
Daily allowance type (AllowanceCode)	xs:int	Codes: AllowanceCode	M	If "Daily allowance type" is "Meal allowance", the "Meal allowance" income type may not be included in the report.



2.38 Kilometre allowance (tax-exempt) (KmAllowance)

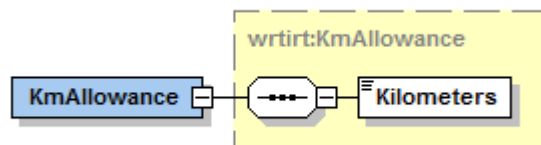

Data group details:

Data designation	Type	Allowed values	V/M	Processing rule
Kilometre allowance (tax-exempt) (KmAllowance)	wrtirt:KmAllowance		V	This data group may be specified only for the "Kilometre allowance (tax-exempt)" income type.
Number of kilometres (Kilometers)	xs:int		M	The value must be greater than or equal to 0.



2.39 Six-month rule (SixMonthRule)

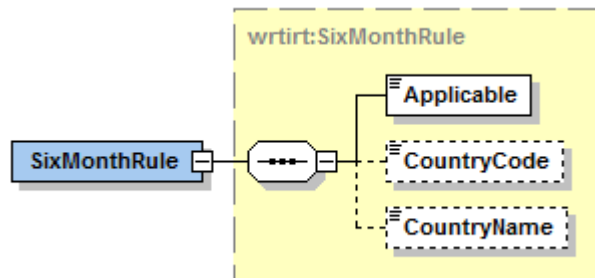

Data group details:

Data designation	Type	Allowed values	V/M	Processing rule
Six-month rule (SixMonthRule)	wrtirt:SixMonthRule		V	The data cannot be provided if the "Income earner type" (IncomeEarnerType) specified in the report is "Person receiving wages for insurance purposes under the Act on EPPO" (16).
Six-month rule is applicable (Applicable)	irct:trueOrFalse		M	
Country code (CountryCode)	irct:String2	A two-character code in accordance with the ISO 3166 country codes. If the country is unknown, the value "99" is entered.	V/M	Mandatory data, if "Six-month rule is applicable" is "true".
Country name (CountryName)	irct:String70		V/M	Mandatory data if "Country code" is "99".



2.40 Details on foreign leased workforce (ForeignLeasedWork)

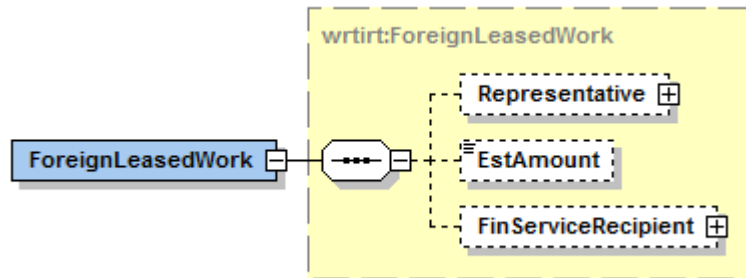

Data group details:

Data designation	Type	Allowed values	V/M	Processing rule
Details on foreign leased workforce (ForeignLeasedWork)	wrtirt:ForeignLeasedWork		V/M	
Representative (Representative)	wrtirt:Representative		V	
Estimated pay amount (EstAmount)	irct:decimal2		V/M	Mandatory data if a form for work abroad where "Form type" is "Employee leasing notice" has been included in the report. The value must be greater than or equal to 0.
Finnish employers (FinServiceRecipient)	wrtirt:FinServiceRecipient		V/M	



2.41 Representative (Representative)

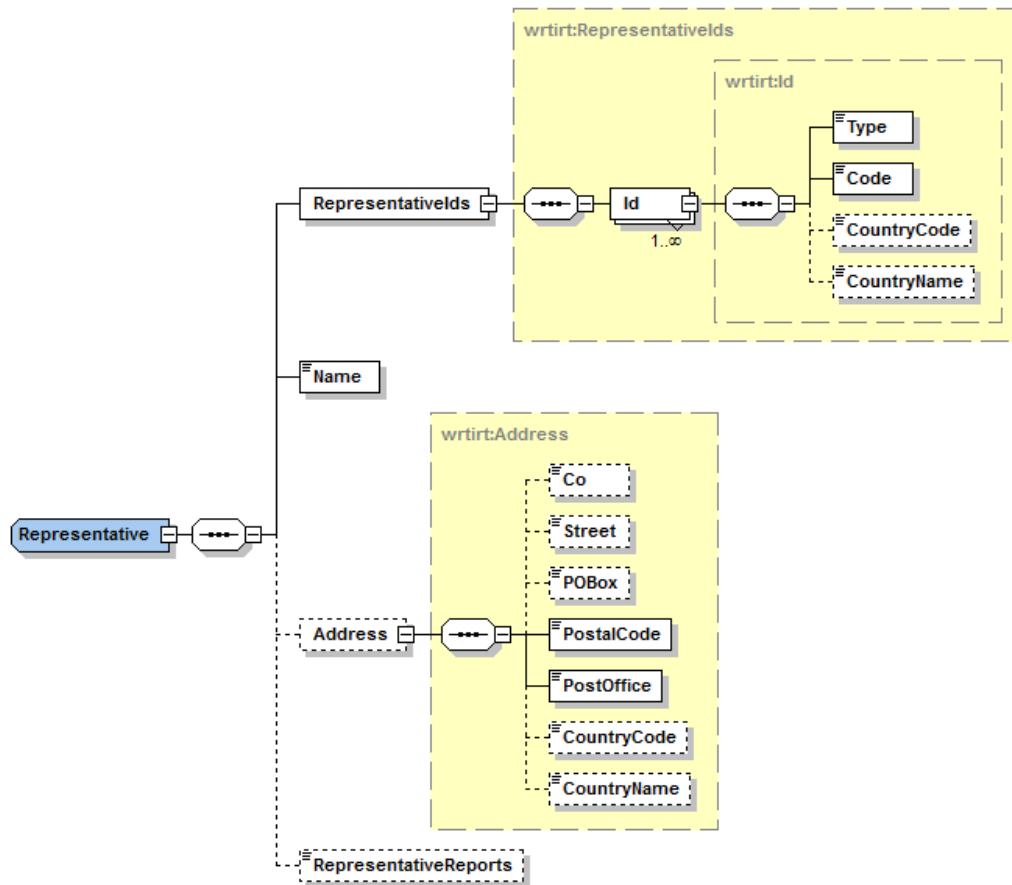

Data group details:

Data designation	Type	Allowed values	V/M	Processing rule
Representative (Representative)	wrtirt:Representative		V	The data group must include at least the "Representative's name" and at least one "Representative identifier" value.



Data designation	Type	Allowed values	V/M	Processing rule
Representative identifiers (Representativelds)	wrtirt:Representativelds		M	If multiple identifiers have been given in the data group, the identifier types cannot be the same. The same combination of identifier type and country code cannot be entered multiple times. There can only be one identifier type of "Finnish Personal Identification Number" or "Finnish Business ID" in the data group.
Representative identifier (Id)	wrtirt:Id		M	Several representative identifiers can be specified. If the representative is given both a Business ID and a Finnish Personal Identification Number, the identifiers must refer to the same customer.
Identifier type (Type)	xs:int	Codes: IdType	M	
Identifier (Code)	irct:String30		M	If the "Identifier type" is other than "Business ID" or "Finnish Personal Identification Number", the identifier must not be Finnish personal identification number or Business ID. The data must not begin or end with non-printable whitespace characters, such as spaces. The data cannot contain non-printable whitespace characters, excluding space. The characters that are not to be used, are listed in chapter 1.2 Character set.
Country code (CountryCode)	irct:String2	A two-character code in accordance with the ISO 3166 country codes. If the country is unknown, the value "99" is entered.	V/M	Mandatory data if "Identifier type" is other than "Business ID" or "Finnish Personal Identification Number". Country code "FI" must not be specified, if the specified "Identifier type" is other than "Business ID", "Finnish Personal Identification Number" or "Other identifier". If the "Identifier type" is set as "Finnish Personal Identification Number" or "Finnish Business ID" the country code can only be "FI".
Country name (CountryName)	irct:String70		V/M	Mandatory data, if the "Country code" is "99".



Data designation	Type	Allowed values	V/M	Processing rule
Representative's name (Name)	irct:String200		M	
Representative's address (Address)	wrtirt:Address		V/M	Address details must be specified for the representative, if no identifiers where the "Identifier type" is "Business ID" or "Finnish Personal Identification Number" have been specified for the representative.
c/o (Co)	irct:String70		V	
Street address (Street)	irct:String100		V/M	If the address details are specified, either "Street address" or "P.O. Box" must be specified. Both must not be entered.
P.O. Box (POBox)	irct:String10		V/M	If the address details are specified, either "Street address" or "P.O. Box" must be specified. Both must not be entered.
Postal code (PostalCode)	irct:String20		M	
City (PostOffice)	irct:String200		M	
Country code (CountryCode)	irct:String2	A two-character code in accordance with the ISO 3166 country codes. If the country is unknown, the value "99" is entered.	V/M	Mandatory data, if no identifiers where "Identifier type" is "Business ID" or "Finnish Personal Identification Number" have been specified for the representative.
Country name (CountryName)	irct:String70		V/M	Mandatory data, if the "Country code" is "99".
Representative acts as submitter (RepresentativeReports)	irct:true	"true"	V	



2.42 Finnish employer (FinServiceRecipient)

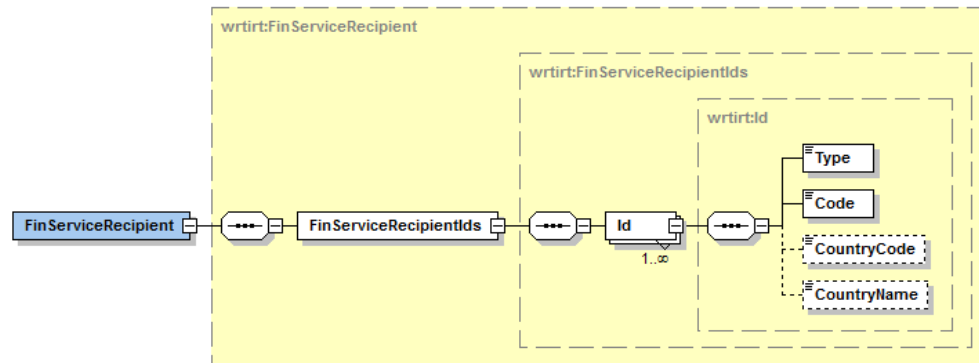

Data group details:

Data designation	Type	Allowed values	V/M	Processing rule
Finnish employer (FinServiceRecipient)	wrtirt:FinServiceRecipient		V/M	Mandatory data group if a form for work abroad where "Form type" is "Employee leasing notice" has been included in the report.
Employer identifiers (FinServiceRecipientIds)	wrtirt:FinServiceRecipientIds		M	If multiple identifiers have been given in the data group, the identifier types cannot be the same. The same combination of identifier type and country code cannot be entered multiple times. There can only be one identifier type of "Finnish Personal Identification Number" or "Finnish Business ID" in the data group.
Employer identifier (Id)	wrtirt:Id		M	Only one employer identifier can be specified.
Identifier type (Type)	xs:int	Codes: IdType	M	
Identifier (Code)	irct:String30		M	If the "Identifier type" is other than "Business ID" or "Finnish Personal Identification Number", the identifier must not be Finnish personal identification number or Business ID. The data must not begin or end with non-printable whitespace characters, such as spaces. The data cannot



Data designation	Type	Allowed values	V/M	Processing rule
				contain non-printable whitespace characters, excluding space. The characters that are not to be used, are listed in chapter 1.2 Character set.
Country code (CountryCode)	irct:String2	A two-character code in accordance with the ISO 3166 country codes. If the country is unknown, the value "99" is entered.	V/M	Mandatory data if "Identifier type" is other than "Business ID" or "Finnish Personal Identification Number". Country code "FI" must not be specified, if the specified "Identifier type" is other than "Business ID", "Finnish Personal Identification Number" or "Other identifier". If the "Identifier type" is set as "Finnish Personal Identification Number" or "Finnish Business ID" the country code can only be "FI".
Country name (CountryName)	irct:String70		V/M	Mandatory data, if the "Country code" is "99".



2.43 Stay periods in Finland (StayPeriodsInFinland)

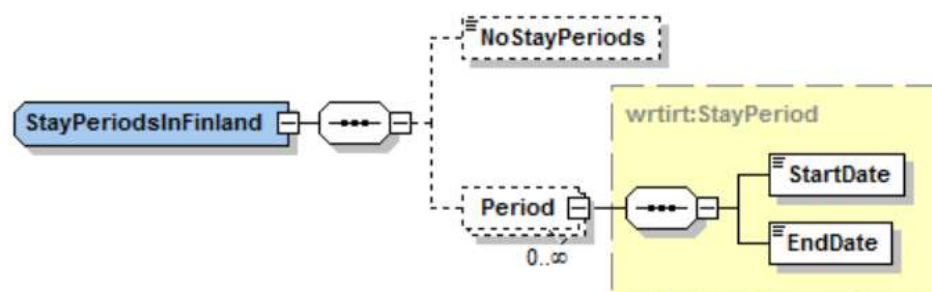

Data group details:

Data designation	Type	Allowed values	V/M	Processing rule
Stay periods in Finland (StayPeriodsInFinland)	wrtirt:StayPeriodsInFinland		V/M	Mandatory data group if a form for work abroad where "Form type" is "Employer's report on periods of stay in Finland" has been included in the report. In such a case, either "Report contains no stay periods in Finland" = true or at least one "Stay period in Finland" data group must be specified. Both must not be specified.
Report contains no stay periods in Finland (NoStayPeriods)	irct:true	"true"	V/M	
Stay period in Finland (Period)	wrtirt:StayPeriod		V/M	Several stay periods in Finland can be specified.
Start date (StartDate)	xs:date		M	The date must not be earlier than 1 January 1800.
End date (EndDate)	xs:date		M	The date must not be earlier than the "Start date".



2.44 Work periods in Finland (WorkPeriodsInFinland)

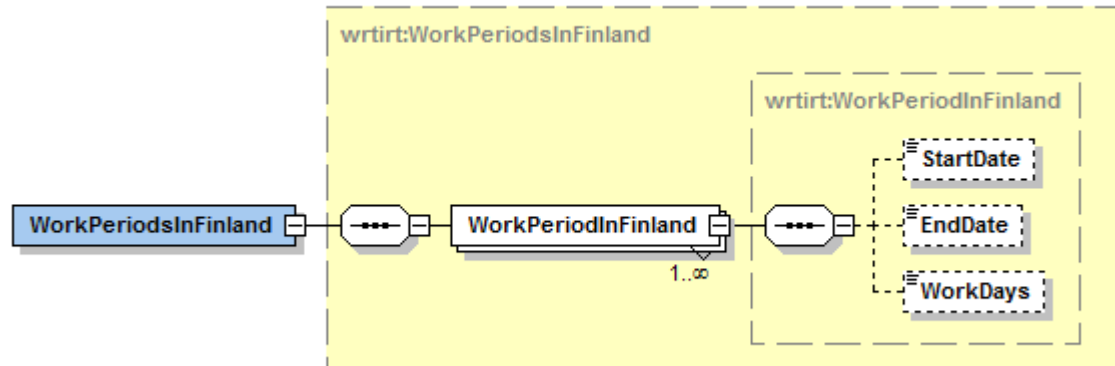

Data group details:

Data designation	Type	Allowed values	V/M	Processing rule
Work periods in Finland (WorkPeriodsInFinland)	wrtirt:WorkPeriodsInFinland		V/M	<p>Mandatory data group if a form for work abroad where "Form type" is "Employee leasing notice" has been included in the report. In such a case, at least one "Work period in Finland" including at least the "Start date" must be specified.</p> <p>Mandatory data group if the value of Type of additional income earner data (IncomeEarnerType) is "Leased employee living abroad", "Leased employee living abroad, working on board a Finnish aircraft" or "Leased employee living abroad, working on board a Finnish ship", the value of Non-resident taxpayer (NonResident) is "true", and the value of Income subject to withholding (SubToWithhold) is not "true". In such a case, at least one "Work period in Finland" must be specified, including at least the "Number of workdays" value.</p>



Data designation	Type	Allowed values	V/M	Processing rule
Work period in Finland (WorkPeriodInFinland)	wrtirt:WorkPeriodInFinland		M	Several work periods in Finland can be specified.
Start date (StartDate)	xs:date		V/M	The date must not be earlier than 1 January 1800.
End date (EndDate)	xs:date		V	The date must not be earlier than the "Start date".
Number of workdays in Finland (WorkDays)	xs:int		V/M	The value must be a non-negative integer.



2.45 Countries of work (WorkCountries)

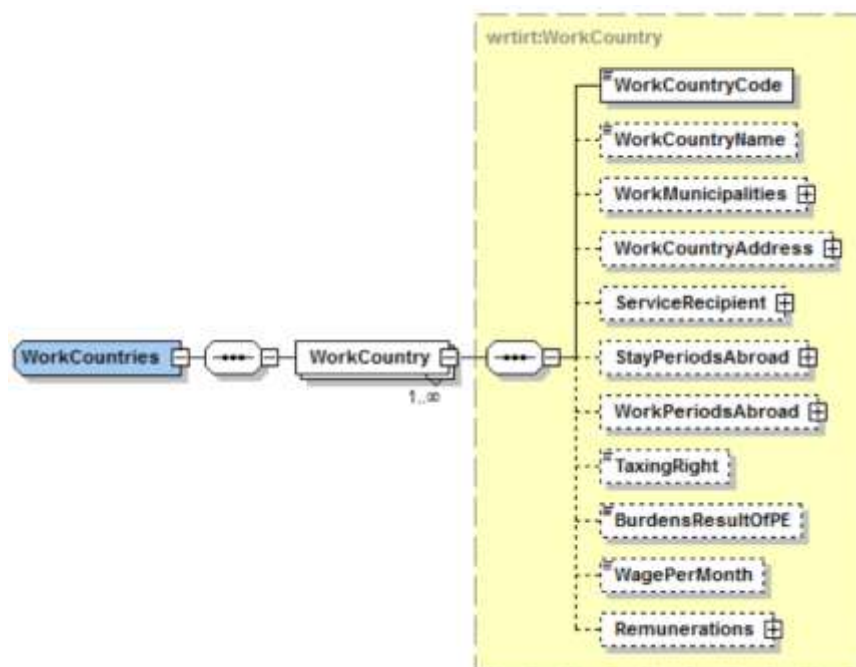

Data group details:

Data designation	Type	Allowed values	V/M	Processing rule
Countries of work (WorkCountries)	wrtirt:WorkCountries		V/M	Mandatory data group if a form for work abroad where "Form type" is "NT1" or "NT2" has been included in the report.
Country of work (WorkCountry)	wrtirt:WorkCountry		M	Several countries of work can be specified.
Code of country of work (WorkCountryCode)	irct:String2	A two-character code in accordance with the ISO 3166 country codes.	M	



Data designation	Type	Allowed values	V/M	Processing rule
		If the country is unknown, the value "99" is entered.		
Name of country of work (WorkCountryName)	irct:String70		V/M	Mandatory data if "Country code" is "99".
Districts of work (WorkMunicipalities)	wrtirt:WorkMunicipalities		V	Several districts of work can be specified for the country of work.
Address in country of work (WorkCountryAddress)	wrtirt:WorkCountryAddress		V	
Principal (ServiceRecipient)	wrtirt:ServiceRecipient		V/M	Mandatory data group, if a form for work abroad where "Form type" is "NT1" has been included in the report.
Stay periods in country of work (StayPeriodsAbroad)	wrtirt:StayPeriodsAbroad		V/M	There may be several stay periods in the country of work. Mandatory data group, if a form for work abroad where "Form type" is "NT1" or "NT2" has been included in the report.
Work periods abroad (WorkPeriodsAbroad)	wrtirt:WorkPeriodsAbroad		V/M	Mandatory data group, if a form for work abroad where "Form type" is "NT2" has been included in the report.
Country of work has taxing right (TaxingRight)	irct:trueOrFalse		V/M	Mandatory data if a form for work abroad where "Form type" is "NT1" or "NT2" has been included in the report.
Pay burdens the result of the employer's permanent establishment in the country of work (BurdensResultOfPE)	irct:trueOrFalse		V/M	Mandatory data if a form for work abroad where "Form type" is "NT1" or "NT2" has been included in the report.
Pay per month (WagePerMonth)	irct:decimal2		V	This data group may only be used if a form for work abroad, where "Form type" is "NT2", has been included in the report.
Other remunerations and benefits (Remunerations)	wrtirt:Remunerations		V	This data group may only be used if a form for work abroad, where "Form type" is "NT2", has been included in the report.



2.46 Districts of work (WorkMunicipalities)

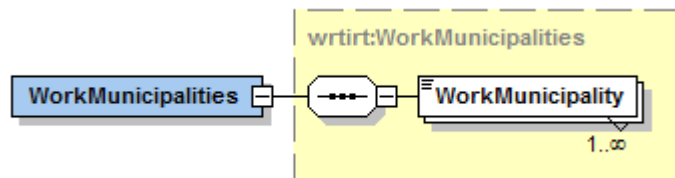

Data group details:

Data designation	Type	Allowed values	V/M	Processing rule
Districts of work (WorkMunicipalities)	wrtirt:WorkMunicipalities		V	
District of work (WorkMunicipality)	irct:String200		M	Several districts of work can be specified for the country of work.



2.47 Address in country of work (WorkCountryAddress)

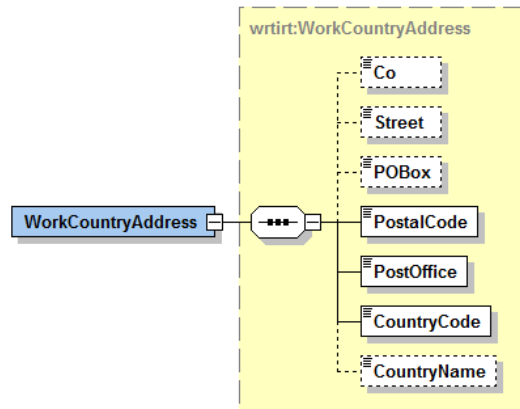

Data group details:

Data designation	Type	Allowed values	V/M	Processing rule
Address in country of work (WorkCountryAddress)	wrtirt:WorkCountryAddress		V	
c/o (Co)	irct:String70		V	
Street address (Street)	irct:String100		V/M	Either "Street address" or "P.O. Box" must be specified in this data group. Both must not be entered.
P.O. Box (POBox)	irct:String10		V/M	Either "Street address" or "P.O. Box" must be specified in this data group. Both must not be entered.
Postal code (PostalCode)	irct:String20		M	
City (PostOffice)	irct:String200		M	
Country code (CountryCode)	irct:String2	A two-character code in accordance with the ISO 3166 country codes.	M	



Data designation	Type	Allowed values	V/M	Processing rule
		If the country is unknown, the value "99" is entered.		
Country name (CountryName)	irct:String70		V/M	Mandatory data if "Country code" is "99".



2.48 Principal (ServiceRecipient)

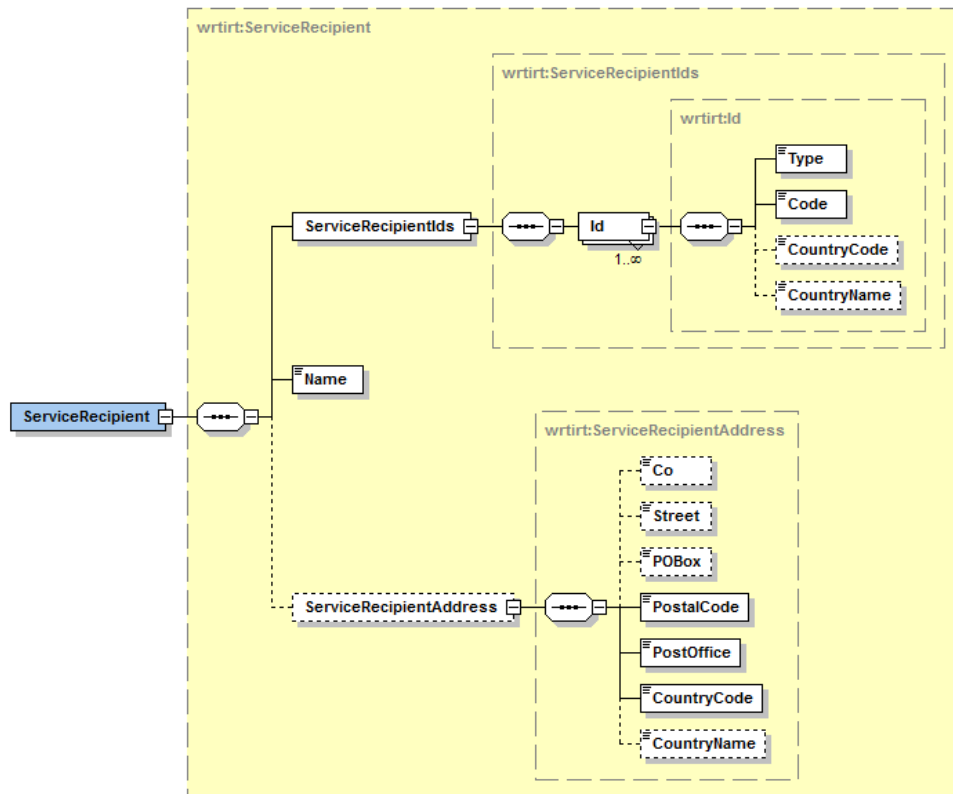

Data group details:

Data designation	Type	Allowed values	V/M	Processing rule
Principal (ServiceRecipient)	wrtirt:ServiceRecipient		V/M	Mandatory data group, if a form for work abroad where "Form type" is "NT1" has been included in the report. At least "Principal identifier" and "Principal's name" must be specified in this data group.
Principal identifiers (ServiceRecipientIds)	wrtirt:ServiceRecipientIds		M	If multiple identifiers have been given in the data group, the identifier types cannot be the same. The same combination of



Data designation	Type	Allowed values	V/M	Processing rule
				identifier type and country code cannot be entered multiple times. There can only be one identifier type of "Finnish Personal Identification Number" or "Finnish Business ID" in the data group.
Principal identifier (Id)	wrtirt:Id		M	A principal can have several identifiers.
Identifier type (Type)	xs:int	Codes: IdType	M	
Identifier (Code)	irct:String30		M	<p>If the "Identifier type" is other than "Business ID" or "Finnish Personal Identification Number", the identifier must not be Finnish personal identification number or Business ID.</p> <p>The data must not begin or end with non-printable whitespace characters, such as spaces. The data cannot contain non-printable whitespace characters, excluding space. The characters that are not to be used, are listed in chapter 1.2 Character set.</p>
Country code (CountryCode)	irct:String2	A two-character code in accordance with the ISO 3166 country codes. If the country is unknown, the value "99" is entered.	V/M	<p>Mandatory data if "Identifier type" is other than "Business ID" or "Finnish Personal Identification Number".</p> <p>Country code "FI" must not be specified, if the specified "Identifier type" is other than "Business ID", "Finnish Personal Identification Number" or "Other identifier".</p> <p>If the "Identifier type" is set as "Finnish Personal Identification Number" or "Finnish Business ID" the country code can only be "FI".</p>
Country name (CountryName)	irct:String70		V/M	Mandatory data, if the "Country code" is "99".
Principal's name (Name)	irct:String200		M	
Principal's address (ServiceRecipientAddress)	wrtirt:ServiceRecipientAddress		V/M	Mandatory data group, if no identifiers where "Identifier type" is "Business ID" or "Finnish Personal Identification Number" have been specified for the principal.
c/o (Co)	irct:String70		V	



Data designation	Type	Allowed values	V/M	Processing rule
Street address (Street)	irct:String100		V/M	Either "Street address" or "P.O. Box" must be specified in this data group. Both must not be entered.
P.O. Box (POBox)	irct:String10		V/M	Either "Street address" or "P.O. Box" must be specified in this data group. Both must not be entered.
Postal code (PostalCode)	irct:String20		M	
City (PostOffice)	irct:String200		M	
Country code (CountryCode)	irct:String2	A two-character code in accordance with the ISO 3166 country codes. If the country is unknown, the value "99" is entered.	M	
Country name (CountryName)	irct:String70		V/M	Mandatory data, if the "Country code" is "99".



2.49 Stay periods in country of work (StayPeriodsAbroad)

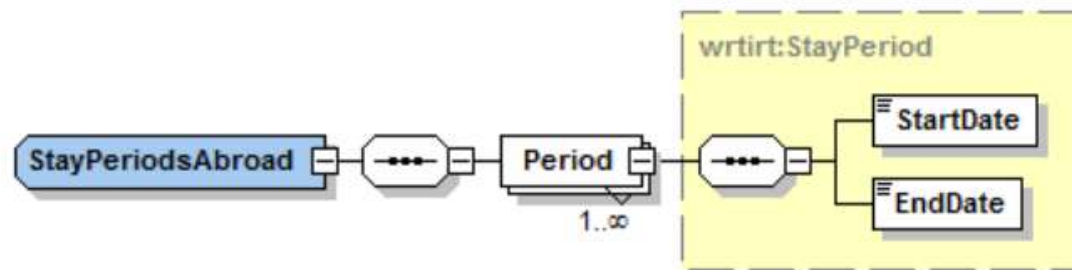

Data group details:

Data designation	Type	Allowed values	V/M	Processing rule
Stay periods in country of work (StayPeriodsAbroad)	wrtirt:StayPeriodsAbroad		V/M	Mandatory data group, if a form for work abroad where "Form type" is "NT1" or "NT2" has been included in the report.
Stay period in country of work (Period)	wrtirt:StayPeriod		M	There may be several stay periods in the country of work.
Start date (StartDate)	xs:date		M	The date must not be earlier than 1 January 1800.
End date (EndDate)	xs:date		M	The "End date" may not be earlier than the "Start date".



2.50 Work periods abroad (WorkPeriodsAbroad)

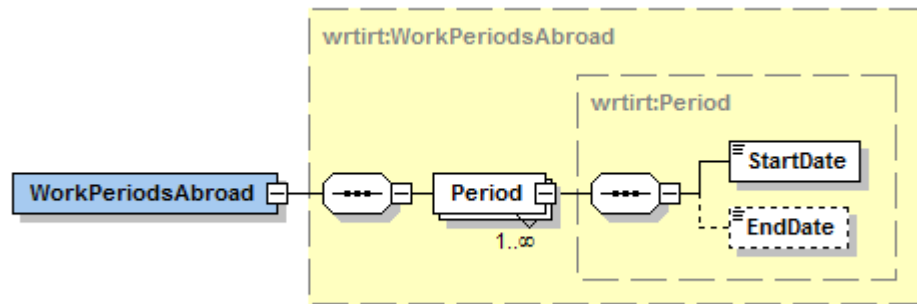

Data group details:

Data designation	Type	Allowed values	V/M	Processing rule
Work periods abroad (WorkPeriodsAbroad)	wrtirt:WorkPeriods Abroad		V/M	Mandatory data group, if a form for work abroad where "Form type" is "NT2" has been included in the report.
Work period abroad (Period)	wrtirt:Period		M	There may be several work periods abroad.
Start date (StartDate)	xs:date		M	The date must not be earlier than 1 January 1800.
End date (EndDate)	xs:date		V	The "End date" may not be earlier than the "Start date".



2.51 Other remunerations and benefits (Remunerations)

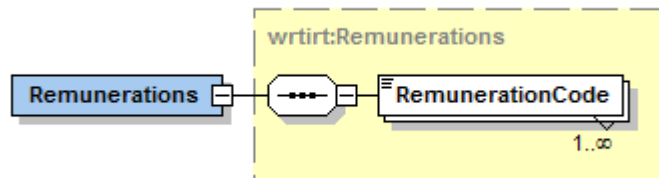

Data group details:

Data designation	Type	Allowed values	V/M	Processing rule
Other remunerations and benefits (Remunerations)	wrtirt:Remunerations		V	This data group may appear only if a form for work abroad where "Form type" is "NT2" has been included in the report.
Benefit type (RemunerationCode)	xs:int	Codes: RemunerationCode	M	There may be several benefit types.



2.52 Absences (Absence)

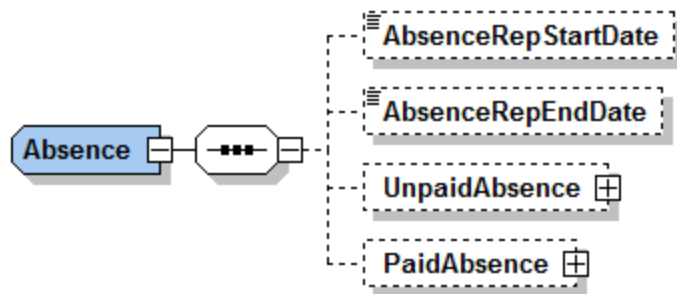

Data group details:

Data designation	Type	Allowed values	V/M	Processing rule
Absences (Absence)	wrtirt:Absence		V	If the details on the time period for reporting absences are specified in the data group, both the Start date of the time period for reporting absences and the End date of the time period for reporting absences data items must be specified.
Start date of the time period for reporting absences (AbsenceRepStartDate)	xs:date		V/M	The date must not be earlier than 1 January 1800. This information is mandatory if the report contains at least one Paid absence. This information is mandatory if the report contains at least one Unpaid absence.
End date of the time period for reporting absences (AbsenceRepEndDate)	xs:date		V/M	The "End date" may not be earlier than the "Start date". This information is mandatory if the report contains at least one Paid absence. This information is mandatory if the report contains at least one Unpaid absence.
Unpaid absence (UnpaidAbsence)	wrtirt:UnpaidAbsence		V/M	There may be several absence periods.
Paid absence (PaidAbsence)	wrtirt:PaidAbsence		V/M	There may be several absence periods.



2.53 Unpaid absence (UnpaidAbsence)

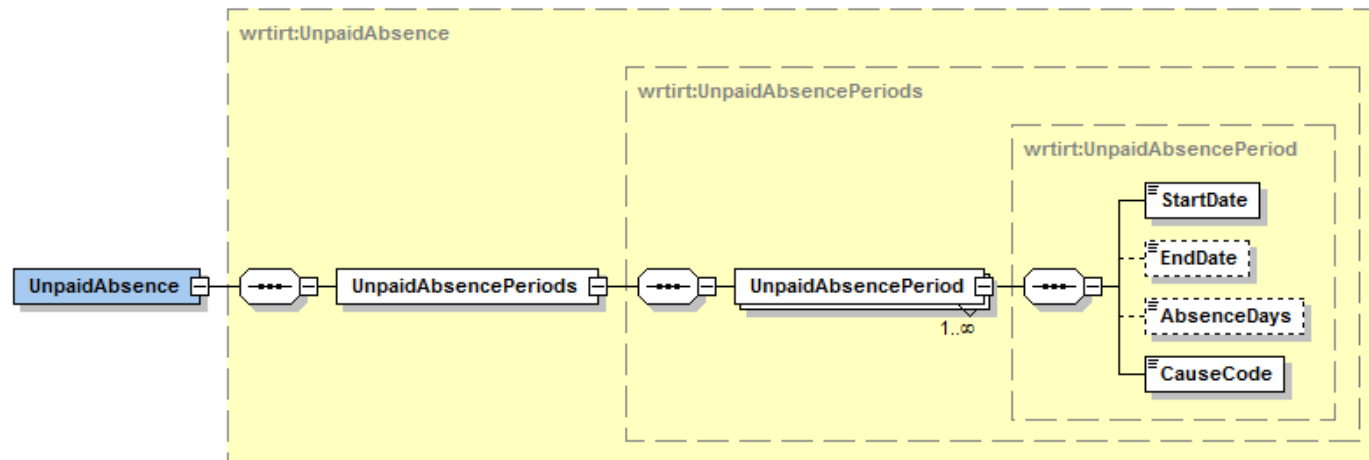

Data group details:

Data designation	Type	Allowed values	V/M	Processing rule
Unpaid absence (UnpaidAbsence)	wrtirt:UnpaidAbsence		V/M	
Absence periods (UnpaidAbsencePeriods)	wrtirt:UnpaidAbsencePeriods		M	
Absence period (UnpaidAbsencePeriod)	wrtirt:UnpaidAbsencePeriod		M	There may be several absence periods.
Start date (StartDate)	xs:date		M	The date must not be earlier than 1 January 1800.
End date (EndDate)	xs:date		V	The "End date" may not be earlier than the "Start date".
Number of days of absence (AbsenceDays)	xs:int		V	The value must be a non-negative number.
Cause of absence (CauseCode)	xs:int	Codes: UnpaidAbsenceCauseCode	M	



2.54 Paid absence (PaidAbsence)

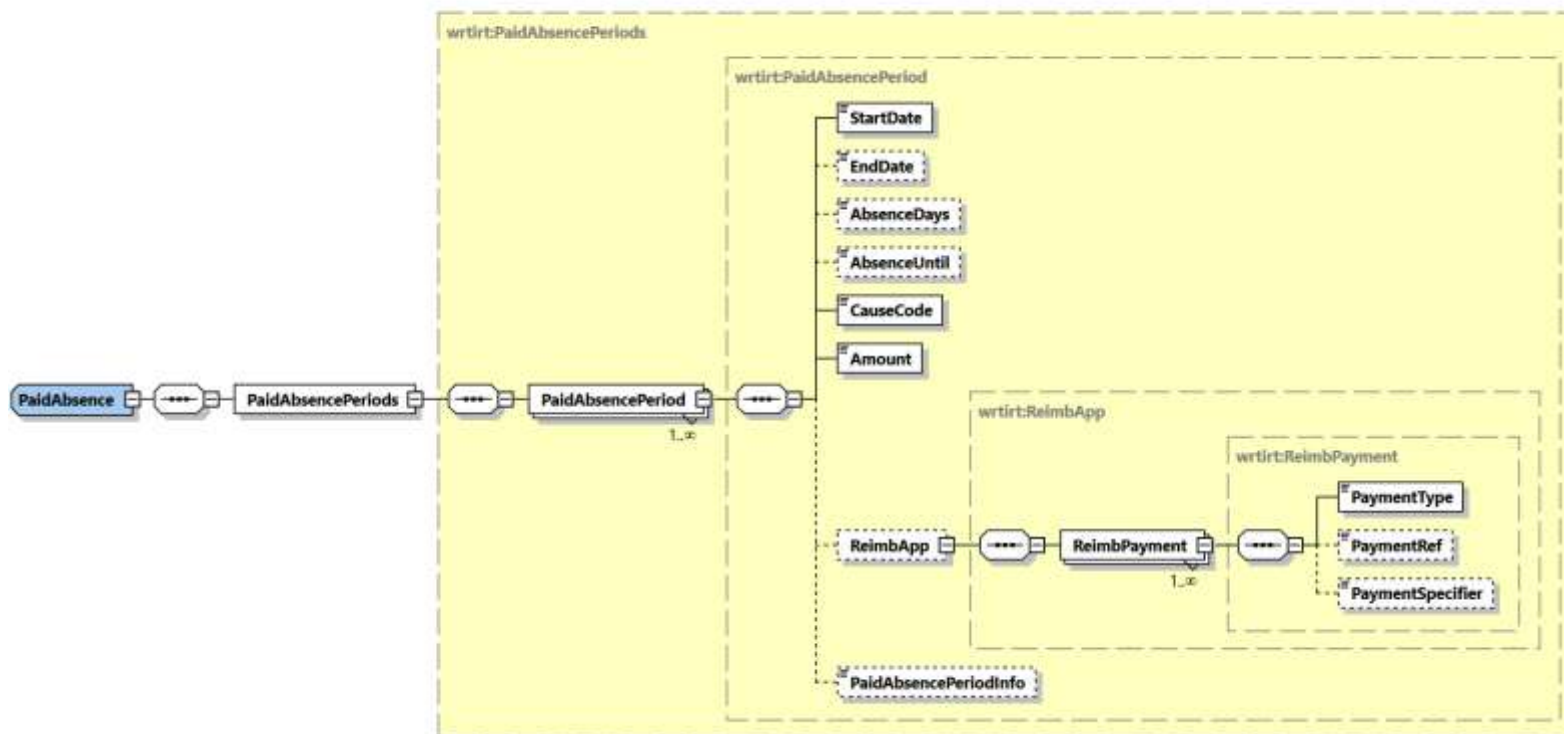

Data group details:

Data designation	Type	Allowed values	V/M	Processing rule
Paid absence (PaidAbsence)	wrtirt:PaidAbsence		V/M	
Absence periods (PaidAbsencePeriods)	wrtirt:PaidAbsence Periods		M	



Data designation	Type	Allowed values	V/M	Processing rule
Absence period (PaidAbsencePeriod)	wrtirt:PaidAbsencePeriod		M	There may be several absence periods.
Start date (StartDate)	xs:date		M	The date must not be earlier than 1 January 1800.
End date (EndDate)	xs:date		V/M	<p>The "End date" may not be earlier than the "Start date"</p> <p>Mandatory data if 1, 2 or 3 was specified as the 'Payment data type' in the 'Reimbursement application data' data group.</p> <p>The time period between the 'Start date' and 'End date' of the absence period must not overlap by a single day with the absence period of another paid absence on the same report ('Start date' – 'End date').</p> <p>The time period between the 'Start date' and 'End date' of the absence period must not overlap by a single day with the absence period of an unpaid absence in the same report ('Start date' – 'End date').</p>
Number of days of absence (AbsenceDays)	xs:int		V	The value must be a non-negative number.
Absence continues, until when (AbsenceUntil)	xs:date		V	"Absence continues, until when" may not be earlier than "Start date".
Cause of absence (CauseCode)	xs:int	Codes: PaidAbsenceCauseCode	M	
Pay for period of paid absence (Amount)	irct:decimal2		M	The value must be greater than 0.
Reimbursement application data (ReimbApp)	wrtirt:ReimbApp		V	
Payment data (ReimbPayment)	wrtirt:ReimbPayment		M	There can be several payment data entries.



Data designation	Type	Allowed values	V/M	Processing rule
				If "Payment data type" is 1, 2 or 3, either "Payment's reference number" or "Payment specifier" must be specified, but not both.
Payment data type (PaymentType)	xs:int	Codes ReimbPaymentType	M	<p>If 'Payment data type' = 1 (Kela, daily allowance application), the 'Reason for unpaid absence' must only be one of the following: 1 (illness), 2 (part-time sick leave), 3 (parental leave), 4 (special pregnancy leave) or 5 (rehabilitation).</p> <p>If 'Payment data type' = 2 (Kela, family leave compensation), the 'Reason for unpaid absence' must be 3 (parental leave).</p> <p>If 'Payment data type' = 3 (Kela, compensation for annual leave costs), the 'Reason for paid absence' must be 23 (compensation for annual leave costs).</p>
Payment's reference number (PaymentRef)	irct:String50		V	The value cannot be over 20 characters.
Payment specifier (PaymentSpecifier)	irct:String200		V	The value cannot be over 29 characters.
Additional reimbursement application data (PaidAbsencePeriodInfo)	irct:string850		V	You can enter freeform text as additional information. This information may be entered only when the 'Reimbursement application data' data group has been specified in connection with the absence period. In other situations, the additional information must not be specified.

