

## **Data distribution – Schemas – Employer's separate reports 2022**

---

### **Incomes Register Unit**

## Version history

Version	Date	Description
1.0	07/06/2021	Published a version of the document containing the 2022 changes to the data contents. The changes apply when the payment date of the income is on 1 January 2022 or later.
		Added the Payer types (PayerTypes) element into the Other payer details (PayerOther) data group.
1.01	03/02/2022	The codeset for permissible values is now corrected, i.e. changed to PayerSubOrgType under the 'Suborganisation's identifier type' in the 'Payer's suborganisations' element.



## CONTENTS

<b>1</b>	<b>General</b> .....	<b>4</b>
1.1	Schema .....	4
1.2	Character set .....	4
1.3	Dates and times.....	5
1.4	Document reading instructions.....	6
<b>2</b>	<b>Employer's separate reports (PayerSummaryReportsFromIR)</b> .....	<b>7</b>
2.1	Record subscription details (Subscription).....	9
2.2	Query details (Query).....	11
2.3	Query summary data (Summary).....	12
2.4	Message-level errors (MessageErrors).....	13
2.5	Record-level errors (DeliveryErrors).....	14
2.6	Reports data (Reports).....	15
2.7	Record data (DeliveryData).....	16
2.8	Contact persons for the record (ContactPersons).....	18
2.9	Payer details (Payer).....	19
2.10	Payer identifiers (PayerIds).....	20
2.11	Basic payer details (PayerBasic).....	21
2.12	Payer's address (Address).....	22
2.13	Payer's suborganisations (SubOrgs).....	23
2.14	Earnings-related pension insurances (PensionInsurances).....	24
2.15	Occupational accident insurances (AccidentInsurance).....	25
2.16	Other payer details (PayerOther).....	27
2.17	Service data (ReportData).....	28
2.18	Reporting period (PaymentMonth).....	29
2.19	Income types (Transactions).....	30



## 1 GENERAL

### 1.1 Schema

Employer's separate reports are distributed from the Incomes Register using the **PayerSummaryReportsFromIR** schema.

The namespaces of the schema are as follows:

File name	Prefix	Namespace
	xmlns:xs	http://www.w3.org/2001/XMLSchema
PayerSummaryReportsFromIR.xsd	xmlns:psrfir	http://www.tulorekisteri.fi/2017/1/PayerSummaryReportsFromIR
PayerSummaryReportsFromIRTypes.xsd	xmlns:psrfirt	http://www.tulorekisteri.fi/2017/1/PayerSummaryReportsFromIRTypes
IRCommonTypes.xsd	xmlns:irct	http://www.tulorekisteri.fi/2017/1/IRCommonTypes
StatusMessageTypes.xsd	xmlns:smt	http://www.tulorekisteri.fi/2017/1/StatusMessageTypes
xmldsig-core-schema.xsd	xmlns:ds	http://www.w3.org/2000/09/xmldsig#

Data distributed from the Incomes Register is identical to that submitted to the Incomes Register. The data user's data access profile is taken into account in the distribution.

### 1.2 Character set

The schemas of the Incomes Register use UTF-8, which is the default character set of XML. The file must not contain the Byte Order Mark (BOM) character.

The following table presents the requirements for the conversion of special characters appearing in messages.

Character	Description	Presentation format as an entity
&	ampersand	&amp; conversion is mandatory
<	less than	&lt; conversion is mandatory
>	greater than	&gt; conversion is not mandatory, but conforms with best practices
'	apostrophe	&apos; conversion is not mandatory, but conforms with best practices
"	quotation mark	&quot; conversion is not mandatory, but conforms with best practices
--	double hyphen	This character must not appear in an XML file
/*	slash asterisk	This character must not appear in an XML file
&#	ampersand hash	This character must not appear in an XML file

A limited character set is allowed for **reference data**. The allowed characters for the reference data listed below are the numbers 0-9, the letters a-z and A-Z and the symbols " \_ " and "-".



- Record owner's record reference (DeliveryId)
- Payer's report reference (ReportId)
- Subscriber's primary subscription reference (MainSubscriptionId)
- Subscriber's secondary subscription reference (SubscriptionId)
- Sender's message reference (MessageId)

In the following data items, upper and lowercase characters are significant:

- Country codes in all data groups (for example, "DE" is interpreted to be a different code than "De").
- Customer IDs in all data groups (for example, "150172-999H" is interpreted to be a different ID than "150172-999h").

### 1.3 Dates and times

Dates (data type xs:date) must not include time zone information. Example of a date:

```
<StartDate>2017-05-11</StartDate>
```

Data elements containing times of day (data types xs:dateTime and xs:time) must include the time zone.

Example in the Finnish time zone (standard time, UTC+2):

```
<Timestamp>2017-05-11T08:00:00+02:00</Timestamp>
```

```
<Time>08:00:00+02:00</Time>
```

Example in UTC time (UTC+0):

```
<Timestamp>2017-05-11T6:00:00Z</Timestamp>
```

```
<Time>06:00:00Z</Time>
```



## 1.4 Document reading instructions

In the document diagrams, the 0 .. ∞ marking in the bottom right-hand corner of an element means that the element may appear several times, or not at all. The 1 .. ∞ marking means that the element may appear several times, but must always appear at least once. The mandatory elements are highlighted with a solid border line and voluntary elements with a dashed border line.

In the document tables, the mandatory or voluntary nature of the elements is depicted with the following markings:

V/M	Description
V	The element is always voluntary. Data groups and data items marked as voluntary are included in the queried record if they contain data (data has been submitted in a report or it is data generated by the Incomes Register) and are included in the data access profile used to query the record.
M	The element is always included if its "parent element" is included.

In some elements, messages use a limited range of values, i.e. codes. The possible values for these codes are described in the "Codes" and "Wages – Codes – Income types" documents. This document refers to the values presented in the codesets using the term "codes".



## 2 EMPLOYER'S SEPARATE REPORTS (PAYERSUMMARYREPORTSFROMIR)

The general structure of a record containing employer's separate reports distributed from the Incomes Register is as follows:

Data group name	Type	V/M
Record subscription details (Subscription)	psrfirt:Subscription	M
Query details (Query)	psrfirt:Query	V
Query summary data (Summary)	psrfirt:Summary	M
Message-level errors (MessageErrors)	smt:MessageErrors	V
Record-level errors (DeliveryErrors)	smt:DeliveryErrors	V
Reports data (Reports)	psrfirt:Reports	V
Report data (Report)	psrfirt:Report	M
Record data (DeliveryData)	psrfirt:DeliveryData	M
Contact persons for the record (ContactPersons)	psrfirt:ContactPersons	V
Payer details (Payer)	psrfirt:Payer	V
Payer identifiers (PayerIds)	psrfirt:PayerIds	V
Basic payer details (PayerBasic)	psrfirt:PayerBasic	V
Payer's address (Address)	psrfirt:Address	V
Payer's suborganisations (SubOrgs)	psrfirt:SubOrgs	V
Earnings-related pension insurances (PensionInsurances)	psrfirt:PensionInsurances	V
Occupational accident insurances (AccidentInsurance)	psrfirt:AccidentInsurances	V
Other payer details (PayerOther)	psrfirt:PayerOther	V
Service data (ReportData)	psrfirt:ReportData	M
Reporting period (PaymentMonth)	psrfirt:PaymentMonth	M
Income types (Transactions)	psrfirt:Transactions	V
Income type details (Transactions)	psrfirt:Transaction	M
General details on the income type (TransactionBasic)	psrfirt:TransactionBasic	M
Signature (Signature)	xsig:SignatureType	M

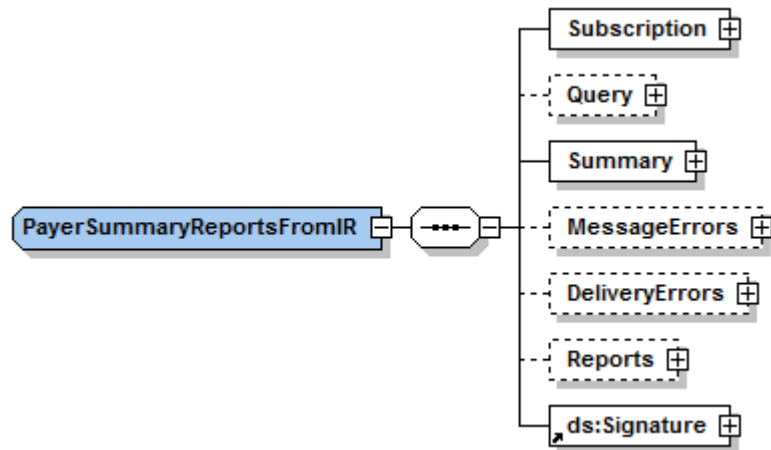

**Data group details:**

Data designation	Type	Allowed values	V/ M	Processing rule
Record subscription details (Subscription)	psrfirt:Subscription		M	This data group is used to distribute information related to a record subscription or a service request.
Query details (Query)	psrfirt:Query		V	This data group is used to distribute information related to a query.  The data group will not appear in the response message to a real-time WS service invocation compliant with the DataRequestToIR schema, if a message-level or record-level error was detected during the processing of the service invocation.
Query summary data (Summary)	psrfirt:Summary		M	This data group is used to distribute summary information related to a query.
Message-level errors (MessageErrors)	smt:MessageErrors		V	This data group can only appear in the response message to a real-time WS service invocation compliant with the DataRequestToIR schema.
Record-level errors (DeliveryErrors)	smt:DeliveryErrors		V	This data group can only appear in the response message to a real-time WS service invocation compliant with the DataRequestToIR schema.
Reports data (Reports)	psrfirt:Reports		V	Employer's separate reports
Signature (Signature)	xsig:SignatureType		M	The electronic signature of the record is delivered in this data group.





## 2.1 Record subscription details (Subscription)

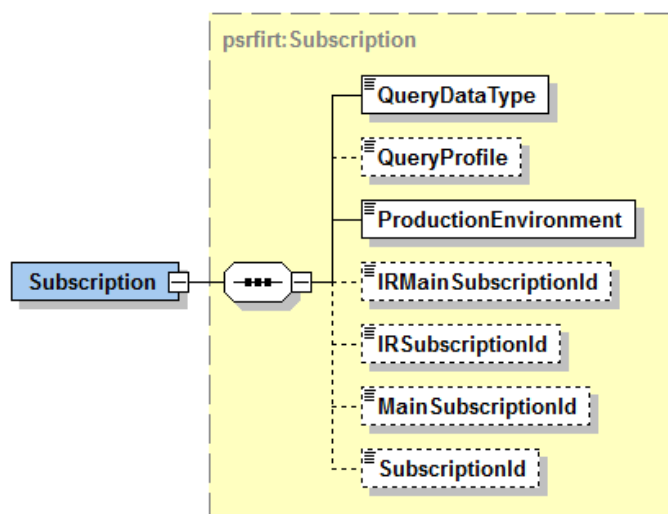

### Data group details:

Data designation	Type	Allowed values	V/ M	Processing rule
Record subscription details (Subscription)	psrfirt:Subscription		M	This data group is used to distribute information related to a record subscription or a service request.
Record type (QueryDataType)	xs:int	Codes: QueryDataType	M	Data submitted in a record subscription or service request.
Data access profile (QueryProfile)	irct:String40		V	Data submitted in a record subscription or service request.
Production environment (ProductionEnvironment)	irct:trueOrFalse	Codes: ProductionEnvironment	M	Data submitted in a record subscription or service request.
Incomes Register primary subscription reference (IRMainSubscriptionId)	irct:Guid		V	The Incomes Register primary subscription reference for the primary subscription based on which the record was queried. The data is not included in the response message to a real-time WS service invocation compliant with the DataRequestToIR schema.
Incomes Register secondary subscription reference (IRSubscriptionId)	irct:Guid		V	The Incomes Register secondary subscription reference for the secondary subscription based on which the record was queried. The data is not included in the response message to a real-time WS service invocation compliant with the DataRequestToIR schema.



Data designation	Type	Allowed values	V/ M	Processing rule
Subscriber's primary subscription reference (MainSubscriptionId)	irct:String40		V	The subscriber's primary subscription reference for the primary subscription based on which the record was queried. The data is not included in the response message to a real-time WS service invocation compliant with the DataRequestToIR schema.
Subscriber's secondary subscription reference (SubscriptionId)	irct:String40		V	The subscriber's secondary subscription reference for the secondary subscription based on which the record was queried. The data is not included in the response message to a real-time WS service invocation compliant with the DataRequestToIR schema.



## 2.2 Query details (Query)

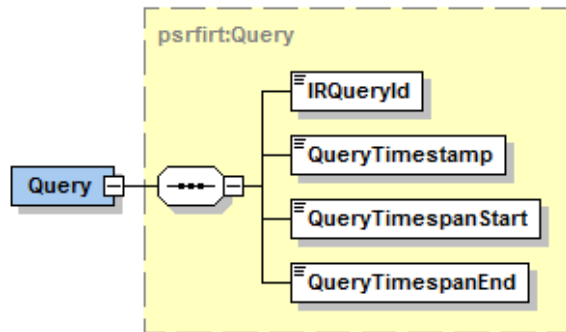

### Data group details:

Data designation	Type	Allowed values	V/ M	Processing rule
Query details (Query)	psrfirt:Query		V	This data group is used to distribute information related to a query.
Incomes Register query reference (IRQueryId)	irct:Guid		M	The reference assigned by the Incomes Register to the queried record. The reference uniquely identifies every record queried from the Incomes Register.
Query time (QueryTimestamp)	xs:dateTime		M	The date and time when the record was queried.
Start of the query time range for changes (QueryTimespanStart)	xs:dateTime		M	The record includes data changed since this date and time.
End of the query time range for changes (QueryTimespanEnd)	xs:dateTime		M	The record includes data changed up to this date and time.



### 2.3 Query summary data (Summary)

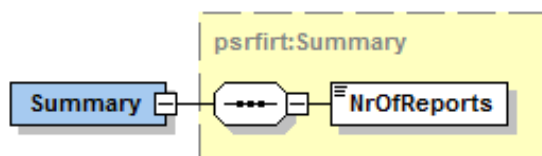

#### Data group details:

Data designation	Type	Allowed values	V/ M	Processing rule
Query summary data (Summary)	psrfirt:Summary		M	This data group is used to distribute summary information related to a query.
The number of queried items (NrOfReports)	xs:int		M	The number of queried employer's separate reports.



## 2.4 Message-level errors (MessageErrors)

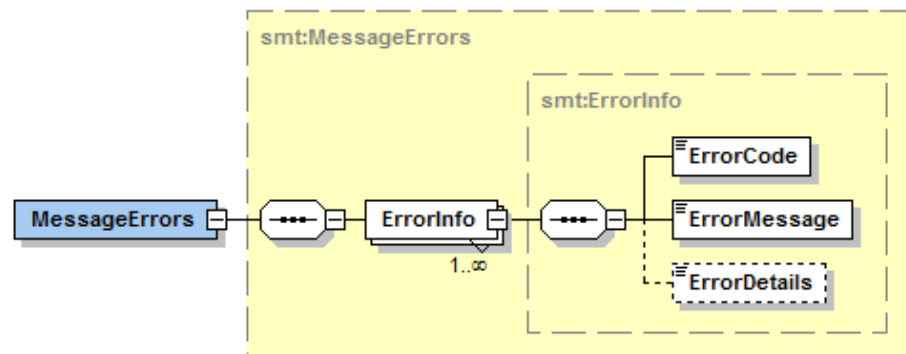

### Data group details:

Data designation	Type	Allowed values	V/ M	Processing rule
Message-level errors (MessageErrors)	smt:MessageErrors		V	This data group is used to return technical and authorisation errors.  This data group can only appear in the response message to a real-time WS service invocation compliant with the DataRequestToIR schema.
Error information (ErrorInfo)	smt:ErrorInfo		M	There may be several errors.
Error code (ErrorCode)	irct:String20		M	The error code is returned in this element.
Error code description (ErrorMessage)	irct:String500		M	A description of the error code is returned in this element.
Error details (ErrorDetails)	irct:String500		V	Allocation and identifying information for the error is returned in this element.



## 2.5 Record-level errors (DeliveryErrors)

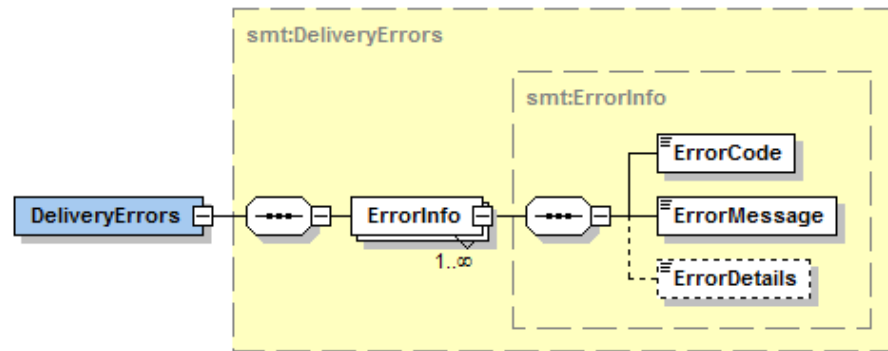

### Data group details:

Data designation	Type	Allowed values	V/ M	Processing rule
Record-level errors (DeliveryErrors)	smt:DeliveryErrors		V	This data group is used to return errors related to the contents of record-level data.  This data group can only appear in the response message to a real-time WS service invocation compliant with the DataRequestToIR schema.
Error information (ErrorInfo)	smt>ErrorInfo		M	There may be several errors.
Error code (ErrorCode)	irct:String20		M	The error code is returned in this element.
Error code description (ErrorMessage)	irct:String500		M	A description of the error code is returned in this element.
Error details (ErrorDetails)	irct:String500		V	Allocation and identifying information for the error is returned in this element.



## 2.6 Reports data (Reports)

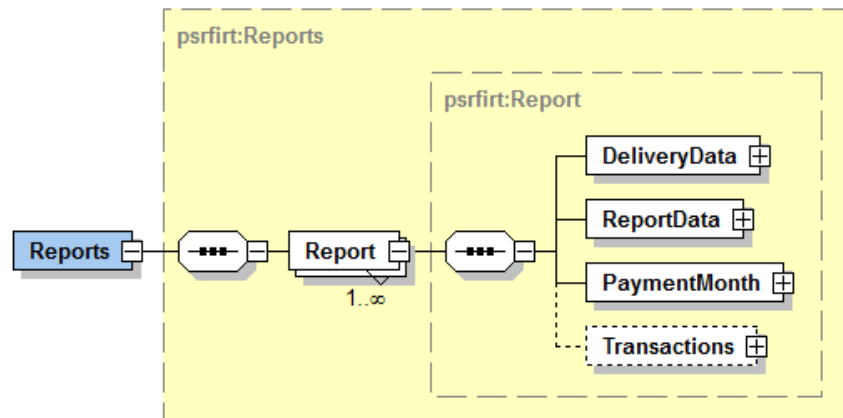

### Data group details:

Data designation	Type	Allowed values	V/ M	Processing rule
Reports data (Reports)	psrfirt:Reports		V	Data groups or data items belonging to this data group and marked as voluntary are returned if they were submitted in the report, and are included in the data access profile used to query the record.
Report data (Report)	psrfirt:Report		M	There may be several reports.
Record data (DeliveryData)	psrfirt:DeliveryData		M	
Service data (ReportData)	psrfirt:ReportData		M	
Reporting period (PaymentMonth)	psrfirt:PaymentMonth		M	
Income types (Transactions)	psrfirt:Transactions		V	



## 2.7 Record data (DeliveryData)

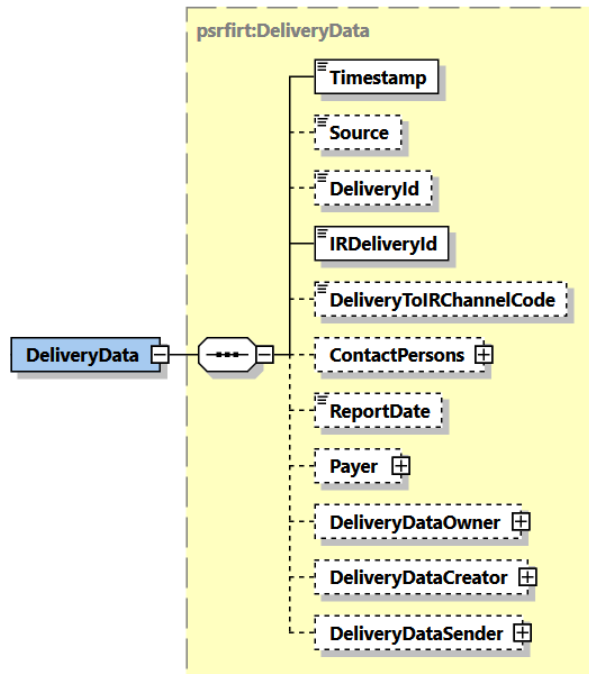

### Data group details:

Data designation	Type	Allowed values	V/ M	Processing rule
Record data (DeliveryData)	psrfirt:DeliveryData		M	Data groups or data items belonging to this data group and marked as voluntary are returned if they were submitted in the report, and are included in the data access profile used to query the record.
Time of record creation (Timestamp)	xs:dateTime		M	
Data source (Source)	irct:String30		V	
Record owner's (payer's) record reference (DeliveryId)	irct:String40		V	





Data designation	Type	Allowed values	V/ M	Processing rule
Incomes Register record reference (IRDeliveryId)	irct:Guid		M	
Record delivery channel (DeliveryToIRChannelCode)	xs:int	Codes: DeliveryToIRChannelCode	V	
Contact persons for the record (ContactPersons)	psrfirt:ContactPersons		V	
Reporting date (Reportdate)	xs:date		V	
Payer details (Payer)	psrfirt:Payer		V	
Record owner (DeliveryDataOwner)	psrfirt:Id		V	
Identifier type (Type)	xs:int	Codes: IdType	V	
Identifier (Code)	irct:String30		V	
Country code (CountryCode)	irct:String2	A two-character code in accordance with the ISO 3166 country codes. If the country is unknown, the value '99' is entered.	V	
Country name (CountryName)	irct:String70		V	
Record creator (DeliveryDataCreator)	psrfirt:Id		V	
Identifier type (Type)	xs:int	Codes: IdType	V	
Identifier (Code)	irct:String30		V	
Country code (CountryCode)	irct:String2	A two-character code in accordance with the ISO 3166 country codes. If the country is unknown, the value '99' is entered.	V	
Country name (CountryName)	irct:String70		V	
Record submitter (DeliveryDataSender)	psrfirt:Id		V	
Identifier type (Type)	xs:int	Codes: IdType	V	
Identifier (Code)	irct:String30		V	
Country code (CountryCode)	irct:String2	A two-character code in accordance with the ISO 3166 country codes. If the country is unknown, the value '99' is entered.	V	



Data designation	Type	Allowed values	V/ M	Processing rule
Country name (CountryName)	irct:String70		V	

## 2.8 Contact persons for the record (ContactPersons)

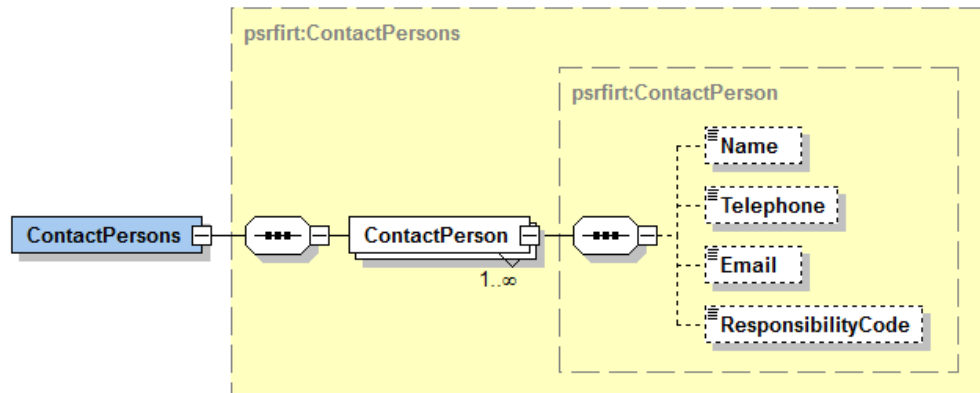

### Data group details:

Data designation	Type	Allowed values	V/ M	Processing rule
Contact persons for the record (ContactPersons)	psrfirt:ContactPersons		V	Data groups or data items belonging to this data group and marked as voluntary are returned if they were submitted in the report, and are included in the data access profile used to query the record.
Contact person for the record (ContactPerson)	psrfirt:ContactPerson		M	There may be several contact persons.
Name (Name)	irct:String200		V	
Telephone number (Telephone)	irct:String40		V	
E-mail address (Email)	irct:String70		V	
Field of responsibility (ResponsibilityCode)	xs:int	Codes: ResponsibilityCode	V	



## 2.9 Payer details (Payer)

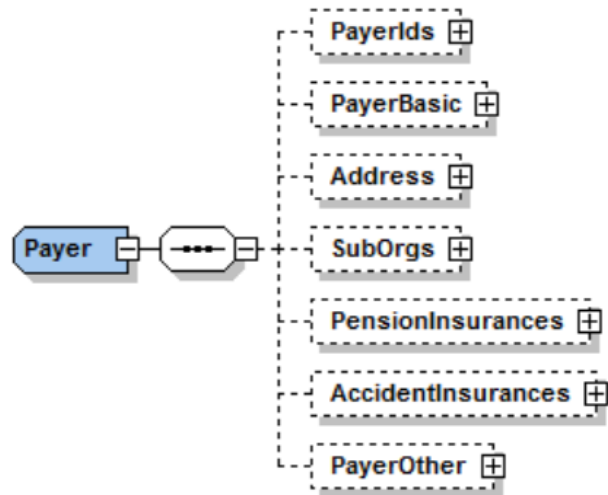

### Data group details:

Data designation	Type	Allowed values	V/ M	Processing rule
Payer details (Payer)	psrfirt:Payer		V	Data groups or data items belonging to this data group and marked as voluntary are returned if they were submitted in the report, and are included in the data access profile used to query the record.
Payer identifiers (PayerIds)	psrfirt:PayerIds		V	
Basic payer details (PayerBasic)	psrfirt:PayerBasic		V	
Payer's address (Address)	psrfirt:Address		V	
Payer's suborganisations (SubOrgs)	psrfirt:SubOrgs		V	
Earnings-related pension insurances (PensionInsurances)	psrfirt:PensionInsurances		V	
Occupational accident insurances (AccidentInsurance)	psrfirt:AccidentInsurances		V	
Other payer details (PayerOther)	psrfirt:PayerOther		V	



## 2.10 Payer identifiers (PayerIds)

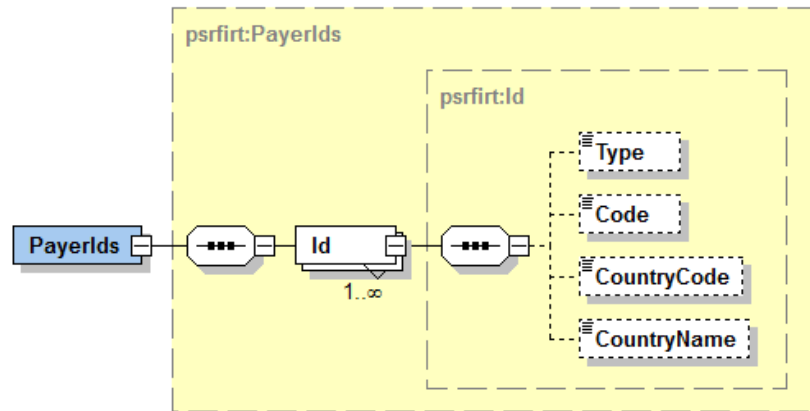

### Data group details:

Data designation	Type	Allowed values	V/ M	Processing rule
Payer identifiers (PayerIds)	psrfirt:PayerIds		V	Data groups or data items belonging to this data group and marked as voluntary are returned if they were submitted in the report, and are included in the data access profile used to query the record.
Payer's ID (Id)	psrfirt:Id		M	A payer can have several identifiers.
Identifier type (Type)	xs:int	Codes: IdType	V	
Identifier (Code)	irct:String30		V	
Country code (CountryCode)	irct:String2	A two-character code in accordance with the ISO 3166 country codes. If the country is unknown, the value is "99".	V	
Country name (CountryName)	irct:String70		V	



## 2.11 Basic payer details (PayerBasic)

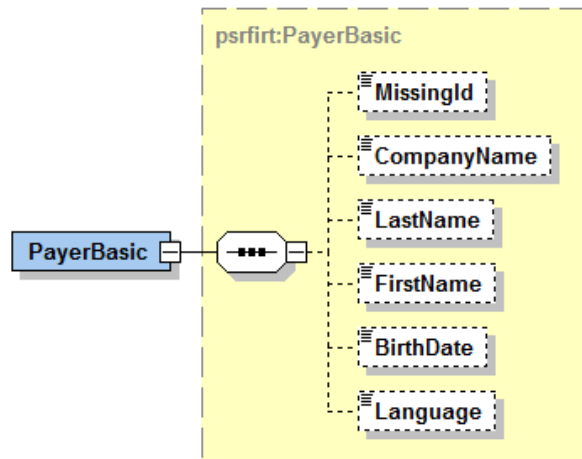

### Data group details:

Data designation	Type	Allowed values	V/ M	Processing rule
Basic payer details (PayerBasic)	psrfirt:PayerBasic		V	Data groups or data items belonging to this data group and marked as voluntary are returned if they were submitted in the report, and are included in the data access profile used to query the record.
The payer does not have a customer ID (MissingId)	irct:true	"true"	V	
Company name (CompanyName)	irct:String200		V	
Last name (LastName)	irct:String200		V	
First name (FirstName)	irct:String100		V	
Date of birth (BirthDate)	xs:date		V	
Contact language (Language)	xs:int	Codes: Language	V	



## 2.12 Payer's address (Address)

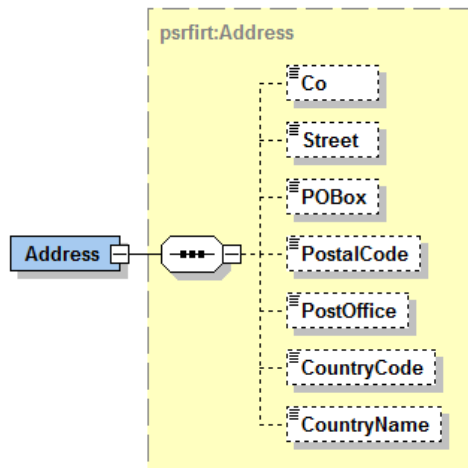

### Data group details:

Data designation	Type	Allowed values	V/ M	Processing rule
Payer's address (Address)	ppsirt:Address		V	Data groups or data items belonging to this data group and marked as voluntary are returned if they were submitted in the report, and are included in the data access profile used to query the record.
c/o (Co)	irct:String70		V	
Street address (Street)	irct:String100		V	
P.O. Box (POBox)	irct:String10		V	
Postal code (PostalCode)	irct:String20		V	
City (PostOffice)	irct:String200		V	
Country code (CountryCode)	irct:String2	A two-character code in accordance with the ISO 3166 country codes. If the country is unknown, the value is "99".	V	
Country name (CountryName)	irct:String70		V	



### 2.13 Payer's suborganisations (SubOrgs)

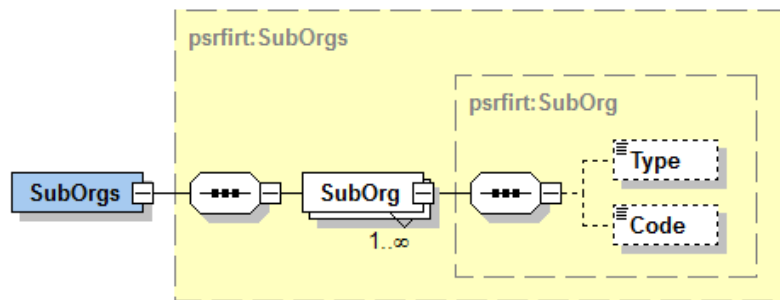

#### Data group details:

Data designation	Type	Allowed values	V/ M	Processing rule
Payer's suborganisations (SubOrgs)	psrfirt:SubOrgs		V	Data groups or data items belonging to this data group and marked as voluntary are returned if they were submitted in the report, and are included in the data access profile used to query the record.
Payer's suborganisation (SubOrg)	psrfirt:SubOrg		M	A payer can have several suborganisations.
Suborganisation's identifier type (Type)	xs:int	Codes: PayerSubOrgType	V	
Suborganisation identifier (Code)	irct:String20		V	



## 2.14 Earnings-related pension insurances (PensionInsurances)

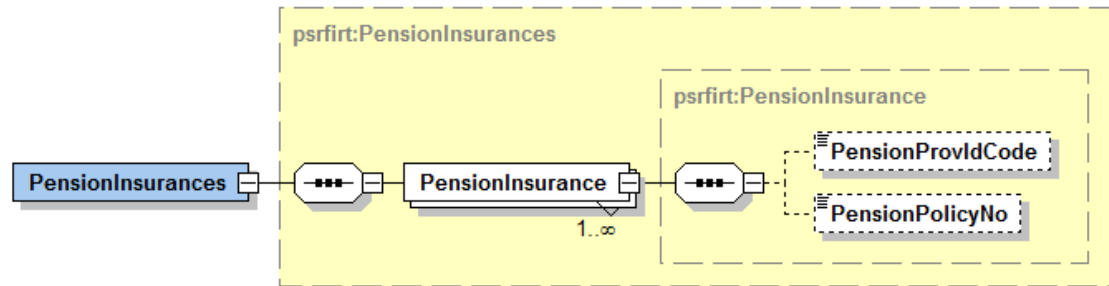

### Data group details:

Data designation	Type	Allowed values	V/ M	Processing rule
Earnings-related pension insurances (PensionInsurances)	psrfirt:PensionInsurances		V	Data groups or data items belonging to this data group and marked as voluntary are returned if they were submitted in the report, and are included in the data access profile used to query the record.
Earnings-related pension insurance (PensionInsurance)	psrfirt:PensionInsurance		M	A payer can have several earnings-related pension insurances.
Pension provider code (PensionProvdCode)	xs:int	Codes: PensionProvdCode	V	
Pension policy number (PensionPolicyNo)	irct:PensionPolicyNo	Pension policy number codes of earnings-related pension providers	V	





## 2.15 Occupational accident insurances (AccidentInsurance)

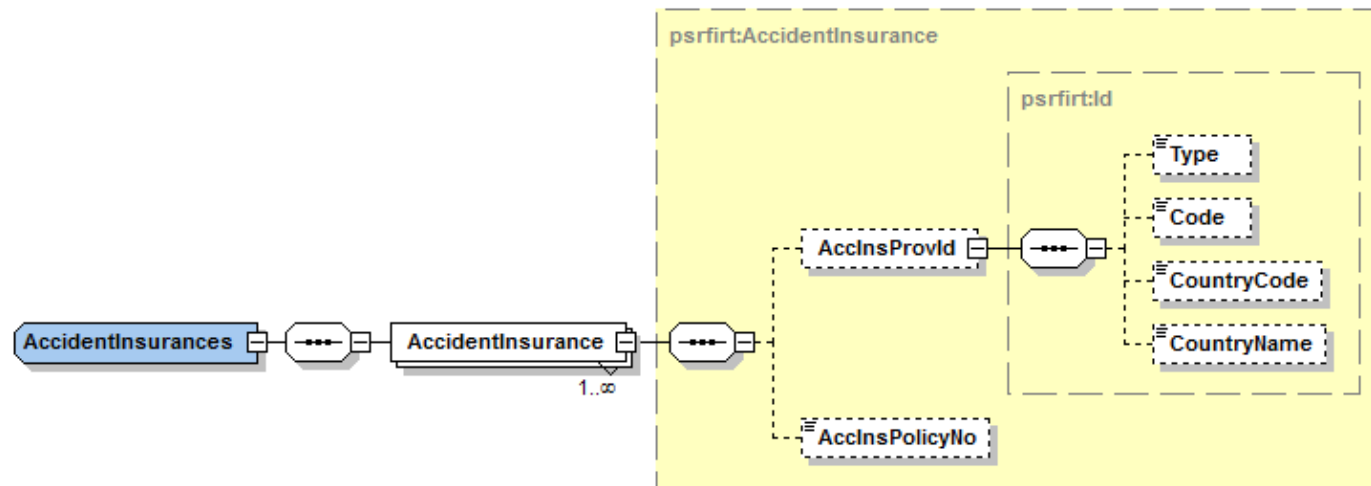

### Data group details:

Data designation	Type	Allowed values	V/ M	Processing rule
Occupational accident insurances (AccidentInsurance)	psrfirt:AccidentInsurances		V	Data groups or data items belonging to this data group and marked as voluntary are returned if they were submitted in the report, and are included in the data access profile used to query the record.
Occupational accident insurance (AccidentInsurance)	psrfirt:AccidentInsurance		M	A payer can have several occupational accident insurances.
Occupational accident insurance company identifier (AccInsProvId)	psrfirt:Id		V	
Identifier type (Type)	xs:int	Codes: IdType	V	
Identifier (Code)	irct:String30		V	
Country code (CountryCode)	irct:String2	A two-character code in accordance with the ISO 3166 country codes. If the country is unknown, the value "99" is entered.	V	
Country name (CountryName)	irct:String70		V	



Data designation	Type	Allowed values	V/ M	Processing rule
Occupational accident insurance policy number (AccInsPolicyNo)	irct:String20		V	



## 2.16 Other payer details (PayerOther)

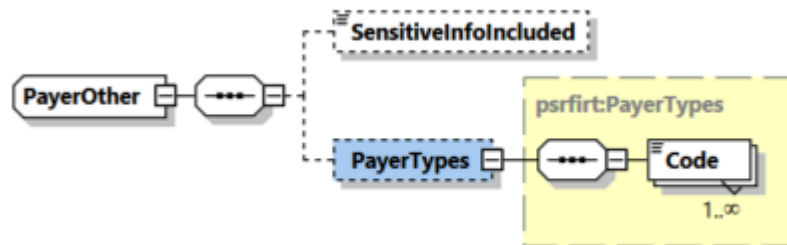

### Data group details:

Data designation	Type	Allowed values	V/ M	Processing rule
Other payer details (PayerOther)	psrfirt:PayerOther		V	Data groups or data items belonging to this data group and marked as voluntary are returned if they were submitted in the report, and are included in the data access profile used to query the record.
Payer's details may include access-restricted data (SensitiveInfoIncluded)	irct:true	"true"	V	The value of this element is "true" if the payer has an access restriction to personal data, and report data is distributed in the Payer's address (Address) data group.
Payer types (PayerTypes)	psrfirt:PayerTypes		V	
Payer type (Code)	xs:int	Codes: PayerType	M	A payer can have several payer types.



## 2.17 Service data (ReportData)

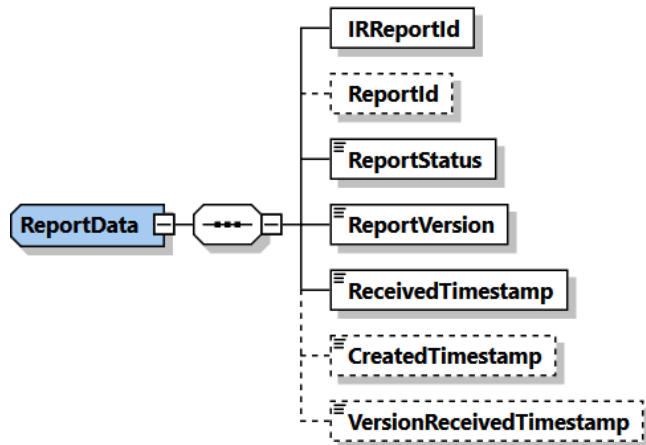

### Data group details:

Data designation	Type	Allowed values	V/ M	Processing rule
Service data (ReportData)	psrfirt:ReportData		M	Data groups or data items belonging to this data group and marked as voluntary are returned if they were submitted in the report, and are included in the data access profile used to query the record.
Incomes Register report reference (IRReportId)	irct:Guid		M	
Payer's report reference (ReportId)	irct:String40		V	
Report status (ReportStatus)	xs:int	Codes: ReportStatus	M	
Report version number (ReportVersion)	xs:int		M	
Reception timestamp of the first version of the report (ReceivedTimestamp)	xs:dateTime		M	The date and time when the first version of the report was received by the Incomes Register.
Report version creation timestamp (CreatedTimestamp)	xs:dateTime		V	The date and time when the report version has been saved in the Incomes Register.
Report version reception timestamp (VersionReceivedTimestamp)	xs:dateTime		V	The date and time when the report version was received by the Incomes Register.



## 2.18 Reporting period (PaymentMonth)

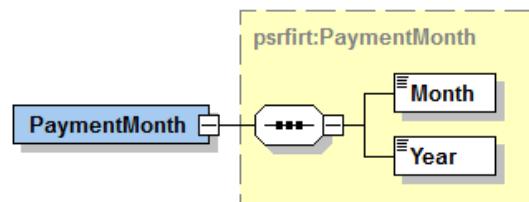

### Data group details:

Data designation	Type	Allowed values	V/ M	Processing rule
Reporting period (PaymentMonth)	psrfirt:PaymentMonth		M	
Payment month (Month)	irct:MonthsType		M	
Payment year (Year)	xs:int		M	



## 2.19 Income types (Transactions)

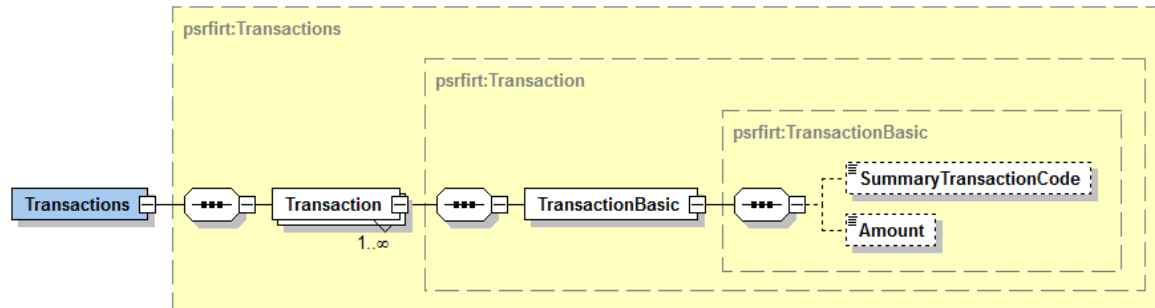

### Data group details:

Data designation	Type	Allowed values	V/ M	Processing rule
Income types (Transactions)	psrfirt:Transactions		V	Data groups or data items belonging to this data group and marked as voluntary are returned if they were submitted in the report, and are included in the data access profile used to query the record.
Income type details (Transactions)	psrfirt:Transaction		M	There may be several income types.
General details on the income type (TransactionBasic)	psrfirt:TransactionBasic		M	
Income type code (SummaryTransactionCode)	xs:int	Codes: SummaryTransactionCode	V	
Amount (Amount)	irct:decimal2		V	

