

Data distribution – Schemas – Summary of payer's earnings payment data 2020

Incomes Register Unit

Version history

Version	Date	Description
1.0	6/11/2019	Document for 2020 published. Contents of the document correspond to the document for 2019.
1.01	21/4/2020	Corrected the text in the Schema section: Previous text: Empty elements are not allowed in the messages. If an element receives no value, the element is left out of the message entirely. Empty character strings are also not allowed, i.e., the minimum length of all values is 1. Corrected to: Data distributed from the Incomes Register is identical to that submitted to the Incomes Register. The data user's data access profile is taken into account in the distribution.

CONTENTS

1	General.....	4
1.1	Schema	4
1.2	Character set	4
1.3	Dates and times.....	5
1.4	Document reading instructions.....	5
2	Summary of payer's earnings payment data (WageReportSummaryFromIR).....	7
2.1	Record subscription details (Subscription).....	9
2.2	Query details (Query).....	11
2.3	Query summary data (Summary).....	12
2.4	Payer details (Payer)	13
2.5	Sum data of earnings payment reports by payment date (WageReportPaymentDatesSummary).....	15
2.6	Sum data by income earner (IncomeEarningsSummary)	19
2.7	Income earner details (IncomeEarner)	21
2.8	Income earner's income data (IncomeEarnerIncome).....	23
2.9	Income (Income)	25
2.10	Unjust enrichment (UnjustEnrichment)	27
2.11	Recovered payments (Recovery).....	28
2.12	Sum data by pension policy number (PensionPolicyNumbersSummary)	30
2.13	Sum data by occupational accident insurance policy number (AccInsPolicyNumbersSummary).....	32



1 GENERAL

1.1 Schema

The summary of payer's earnings payment data is delivered from the Incomes Register using the **WageReportSummaryFromIR** schema.

The namespaces of the schema are the following:

File name	Prefix	Namespace
	xmlns:xs	http://www.w3.org/2001/XMLSchema
WageReportSummaryFromIR.xsd	xmlns:wrsfir	http://www.tulorekisteri.fi/2017/1/WageReportSummaryFromIR
WageReportSummaryFromIRTypes.xsd	xmlns:wrsfirt	http://www.tulorekisteri.fi/2017/1/WageReportSummaryFromIRTypes
IRCommonTypes.xsd	xmlns:irct	http://www.tulorekisteri.fi/2017/1/IRCommonTypes
xmldsig-core-schema.xsd	xmlns:ds	http://www.w3.org/2000/09/xmldsig#

Data distributed from the Incomes Register is identical to that submitted to the Incomes Register. The data user's data access profile is taken into account in the distribution.

1.2 Character set

The schemas of the Incomes Register use UTF-8, which is the default character set of XML. The file must not contain the Byte Order Mark (BOM) character.

The following table presents the requirements for the conversion of special characters appearing in messages.

Character	Description	Presentation format as an entity
&	ampersand	& conversion is mandatory
<	less than	< conversion is mandatory
>	greater than	> conversion is not mandatory, but conforms with best practices
'	apostrophe	' conversion is not mandatory, but conforms with best practices
"	quotation mark	" conversion is not mandatory, but conforms with best practices
--	double hyphen	This character must not appear in an XML file
/*	slash asterisk	This character must not appear in an XML file
&#	ampersand hash	This character must not appear in an XML file

Reference data use a limited character set. The allowed characters for the reference data listed below are the numerals 0-9, the letters a-z and A-Z, and the special characters "_" and "-".

- Record owner's record reference (DeliveryId)
- Payer's report reference (ReportId)
- Subscriber's primary subscription reference (MainSubscriptionId)
- Subscriber's secondary subscription reference (SubscriptionId)
- Sender's message reference (MessageId)

In the following data items, upper and lowercase characters are significant:

- Country codes in all data groups (for example, "DE" is interpreted to be a different code to "De").
- Customer IDs in all data groups (for example, "150172-999H" is interpreted to be a different ID to "150172-999h").

1.3 Dates and times

Dates (data type xs:date) must not include time zone information. Example of a date:

```
<StartDate>2017-05-11</StartDate>
```

Data elements containing times of day (data types xs:dateTime and xs:time) must include the time zone.

Example in the Finnish time zone (standard time, UTC+2):

```
<Timestamp>2017-05-11T08:00:00+02:00</Timestamp>
```

```
<Time>08:00:00+02:00</Time>
```

Example in UTC time (UTC+0):

```
<Timestamp>2017-05-11T6:00:00Z</Timestamp>
```

```
<Time>06:00:00Z</Time>
```

1.4 Document reading instructions

In the document diagrams, the 0 .. ∞ marking in the bottom right-hand corner of an element means that the element may appear several times or not at all. The 1 .. ∞ marking means that the element may appear several times, but it must always appear at least once. The mandatory elements are highlighted with a solid border line and voluntary elements with a dashed border line.

In the document tables, the mandatory or voluntary nature of the elements is depicted with the following markings:

V/M	Description
V	The element is always voluntary.

	Data groups and data items marked as voluntary are included in the queried record if they contain data (data has been submitted in a report or it is data generated by the Incomes Register) and are included in the data access profile used to query the record.
M	The element is always included if its "parent element" is included.

In some elements, messages use a limited range of values, i.e. codes. The possible values for these codes are described in the "Codes" and "Codes – Income types" documents. This document refers to the values presented in the codesets using the term "codes".

2 SUMMARY OF PAYER'S EARNINGS PAYMENT DATA (WAGEREPORTSUMMARYFROMIR)

The general structure of the summary of payer's earnings payment data distributed from the Incomes Register is as follows:

Data group name	Type	V/M
Record subscription details (Subscription)		M
Query details (Query)		M
Query summary data (Summary)		M
Payer details (Payer)		M
Payer's identifier (PayerId)		M
Payer's suborganisation (SubOrg)		V
Sum data of earnings payment reports by payment date (WageReportPaymentDatesSummary)		V
Payment date sum data (PaymentDateSummary)		M
Sum data by income earner (IncomeEarningsSummary)		M
Income earner's sum data (IncomeEarnerSummary)		M
Income earner details (IncomeEarner)		M
Income earner's income data (IncomeEarnerIncome)		M
Income itemisation (IncomeSummary)		V/M
Submitter type specific income (ReporterSubTypeIncome)		M
Income (Income)		V/M
Unjust enrichment (UnjustEnrichment)		V/M
Recovered payments (Recovery)		V/M
Sum data by pension policy number (PensionPolicyNumbersSummary)		M
Sum data for a pension policy number (PensionPolicyNumberSummary)		M
Earnings-related pension insurance (PensionInsurance)		M
Income data (PensionInsuranceIncome)		M
Sum data by occupational accident insurance policy number (AccInsPolicyNumbersSummary)		M
Sum data for an occupational accident insurance policy number (AccInsPolicyNumberSummary)		M
Occupational accident insurance (AccidentInsurance)		M
Income data (AccidentInsuranceIncome)		M
Signature (Signature)	xsig:SignatureType	M

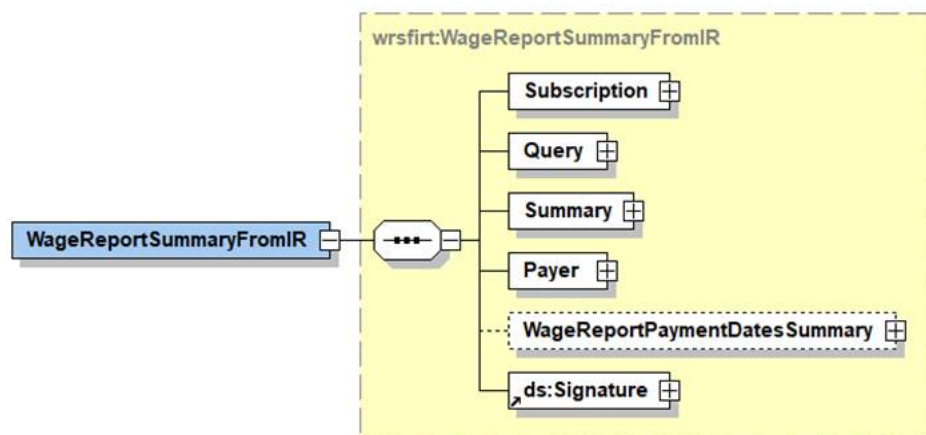
**Data group details:**

Data designation	Type	Allowed values	V/ M	Processing rule
Record subscription details (Subscription)			M	This data group is used to distribute information related to a record subscription.
Query details (Query)			M	This data group is used to distribute information related to a query.
Query summary data (Summary)			M	This data group is used to distribute summary information related to a query.
Payer details (Payer)			M	The payer from whose reports the summary data has been calculated.
Sum data of earnings payment reports by payment date (WageReportPaymentDatesSummary)			V	The sum data for the earnings payment reports submitted for the reporting period, itemised by payment date.
Signature (Signature)	xsig:SignatureType		M	The electronic signature of the record is delivered in this data group.

2.1 Record subscription details (Subscription)

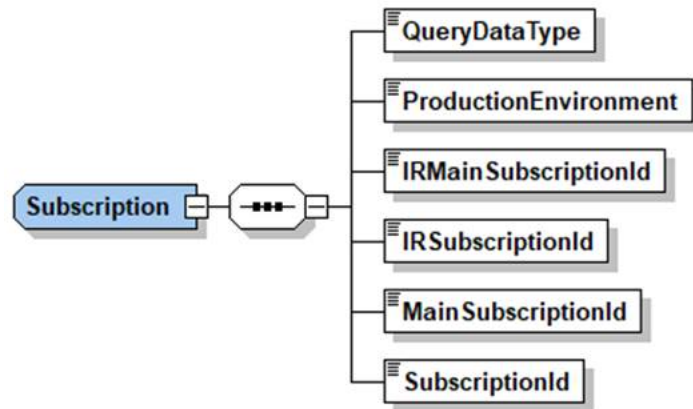

Data group details:

Data designation	Type	Allowed values	V/ M	Processing rule
Record subscription details (Subscription)			M	This data group is used to distribute information related to a record subscription.
Record type (QueryDataType)	xs:int	Codes: QueryDataType and values 312, 313 from it	M	Information provided in a record subscription.
Production environment (ProductionEnvironment)	irct:trueOrFalse	Codes: ProductionEnvironment	M	Information provided in a record subscription.
Incomes Register primary subscription reference (IRMainSubscriptionId)	irct:Guid		M	The Incomes Register primary subscription reference for the primary subscription based on which the record was queried.
Incomes Register secondary subscription reference (IRSubscriptionId)	irct:Guid		M	The Incomes Register secondary subscription reference for the secondary subscription based on which the record was queried.
Subscriber's primary subscription reference (MainSubscriptionId)	irct:String40		M	The subscriber's primary subscription reference for the primary subscription based on which the record was queried.
Subscriber's secondary subscription reference (SubscriptionId)	irct:String40		M	The subscriber's secondary subscription reference for the secondary subscription based on which the record was queried.



2.2 Query details (Query)

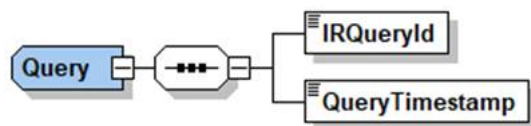

Data group details:

Data designation	Type	Allowed values	V/ M	Processing rule
Query details (Query)			M	This data group is used to distribute information related to a query.
Incomes Register query reference (IRQueryId)	irct:Guid		M	The reference assigned by the Incomes Register to the queried record. The reference uniquely identifies every record queried from the Incomes Register.
Query time (QueryTimestamp)	xs:dateTime		M	The date and time when the record was queried.

2.3 Query summary data (Summary)



Data group details:

Data designation	Type	Allowed values	V/ M	Processing rule
Query summary data (Summary)			M	This data group is used to distribute summary information related to a query.
The number of queried items (NrOfReports)	xs:int		M	The number of earnings payment reports submitted for the reporting period included in the calculation of the sum data.

2.4 Payer details (Payer)

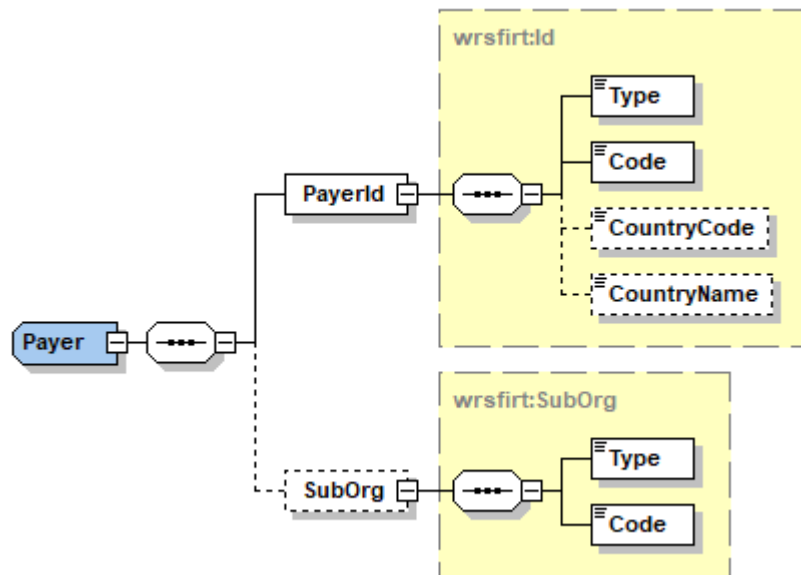

Data group details:

Data designation	Type	Allowed values	V/ M	Processing rule
Payer details (Payer)			M	The payer (specified as a query criterion in a record subscription) from whose reports the sum data is calculated.
Payer's identifier (PayerId)			M	The payer's identifier (specified as a query criterion in a record subscription) from the reports of which the sum data is calculated.
Identifier type (Type)	xs:int	Codes: IdType	M	
Identifier (Code)	irct:String30		M	
Country code (CountryCode)	irct:String2	A two-character code in accordance with the ISO 3166 country codes.	V	



		If the country is unknown, the value is "99".		
Country name (CountryName)	irct:String70		V	
Payer's suborganisation (SubOrg)			V	The payer's suborganisation (specified as a query criterion in a record subscription) from the reports of which the sum data is calculated.
Suborganisation's identifier type (Type)	xs:int	Codes: PayerSubOrgType	M	
Suborganisation identifier (Code)	irct:String20		M	

2.5 Sum data of earnings payment reports by payment date (WageReportPaymentDatesSummary)

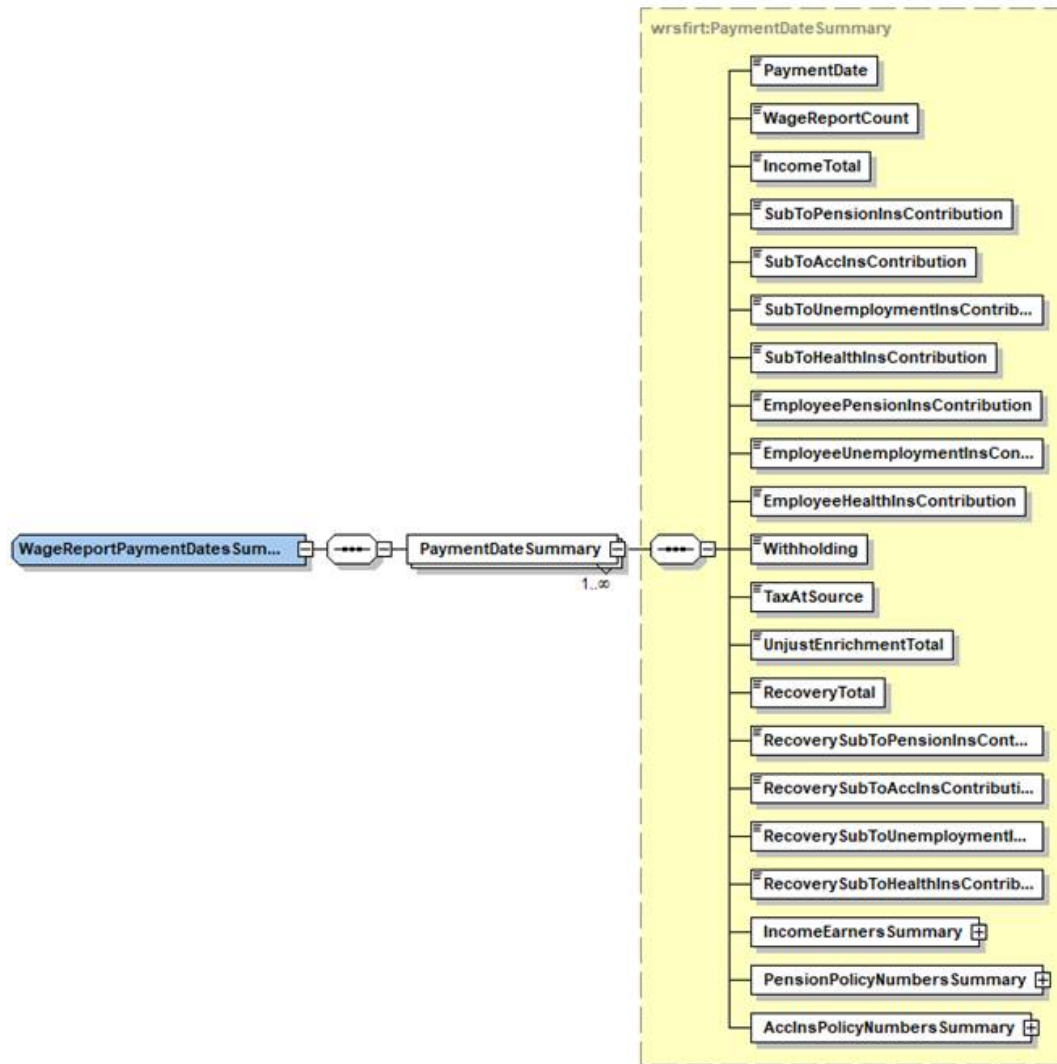

Data group details:

Data designation	Type	Allowed values	V/ M	Processing rule
Sum data of earnings payment reports by payment date (WageReportPaymentDatesSummary)			V	<p>The payment date specific sum data of the earnings payment reports submitted for the reporting period.</p> <p>This data group will not be distributed if there are no earnings payment reports meeting the query criteria in the reporting period.</p> <p>Earnings payment reports are included in the calculation of the sum data according to the specified Submitter type query criterion as follows:</p> <ol style="list-style-type: none"> a. Submitter type is "Payer": <ul style="list-style-type: none"> o Earnings payment reports where the payer (payer specified in the Payer details data group) is the payer specified as the query criterion of the record subscription and the report does not contain substitute payer details (the Substitute payer data group). o Earnings payment reports where the employer specified in connection with the substitute payer details (Employer identifier specified in the Substitute payer data group) is the payer specified as the query criterion of the record subscription. b. Submitter type is "Substitute payer": <ul style="list-style-type: none"> o Earnings payment reports where the payer (payer specified in the Payer details data group) is the payer specified as the query criterion of the record subscription and the report contains substitute payer details (the Substitute payer data group).
Payment date sum data (PaymentDateSummary)			M	<p>Sum data from the earnings payment reports for one payment date.</p> <p>This data group is created for each payment date for which earnings payment reports matching the query criteria specified in the record subscription are found.</p> <p>If there is no income, 0 is distributed as the value.</p>
Date of payment or other report (PaymentDate)	xs:date		M	The payment data based on the report data of which the sum data has been calculated.
Number of earnings payment reports (WageReportCount)	xs:int		M	The number of earnings payment reports for the payment date. Calculation rule: Number of earnings payment reports (WageReportCount)
Payments total (IncomeTotal)	irct:decimal2		M	The income reported for the payment date. Calculation rule: Payments total (IncomeTotal)

Income subject to earnings-related pension insurance contributions (SubToPensionInsContribution)	irct:decimal2		M	The total income subject to earnings-related pension insurance contributions reported for the payment date. Calculation rule: Income subject to earnings-related pension insurance contributions (SubToPensionInsContribution)
Income subject to accident and occupational disease insurance contributions (SubToAccInsContribution)	irct:decimal2		M	The total income subject to accident and occupational disease insurance contributions reported for the payment date. Calculation rule: Income subject to accident and occupational disease insurance contributions (SubToAccInsContribution)
Income subject to unemployment insurance contributions (SubToUnemploymentInsContribution)	irct:decimal2		M	The total income subject to unemployment insurance contributions reported for the payment date. Calculation rule: Income subject to unemployment insurance contributions (SubToUnemploymentInsContribution)
Income subject to health insurance contributions (SubToHealthInsContribution)	irct:decimal2		M	The total income subject to health insurance contributions reported for the payment date. Calculation rule: Income subject to health insurance contributions (SubToHealthInsContribution)
Employee's earnings-related pension insurance contributions (EmployeePensionInsContribution)	irct:decimal2		M	The employee's earnings-related pension insurance contributions reported for the payment date. Calculation rule: Employee's earnings-related pension insurance contributions (EmployeePensionInsContribution)
Employee's unemployment insurance contributions (EmployeeUnemploymentInsContribution)	irct:decimal2		M	The employee's unemployment insurance contributions reported for the payment date. Calculation rule: Employee's unemployment insurance contributions (EmployeeUnemploymentInsContribution)
Employee's health insurance contributions (EmployeeHealthInsContribution)	irct:decimal2		M	The employee's health insurance contributions reported for the payment date. Calculation rule: Employee's health insurance contributions (EmployeeHealthInsContribution)
Withheld taxes (Withholding)	irct:decimal2		M	The withheld taxes reported for the payment date. Calculation rule: Withheld taxes (Withholding)
Tax at source (TaxAtSource)	irct:decimal2		M	The tax at source reported for the payment date. Calculation rule: Tax at source (TaxAtSource)
Unjust enrichment total (UnjustEnrichmentTotal)	irct:decimal2		M	Total unjust enrichment reported for the payment date. Calculation rule: Unjust enrichment total (UnjustEnrichmentTotal)
Recovered payments total (RecoveryTotal)	irct:decimal2		M	Total recovered payments reported for the payment date. Calculation rule: Recovered payments total (RecoveryTotal)
Recovered income subject to earnings-related pension insurance contributions (RecoverySubToPensionInsContribution)	irct:decimal2		M	The total recovered income subject to earnings-related pension insurance contributions reported for the payment date.

				Calculation rule: Recovered income subject to earnings-related pension insurance contributions (RecoverySubToPensionInsContribution)
Recovered income subject to accident and occupational disease insurance contributions (RecoverySubToAcclnsContribution)	irct:decimal2		M	The total recovered income subject to accident and occupational disease insurance contributions reported for the payment date. Calculation rule: Recovered income subject to accident and occupational disease insurance contributions (RecoverySubToAcclnsContribution)
Recovered income subject to unemployment insurance contributions (RecoverySubToUnemploymentInsContribution)	irct:decimal2		M	The total recovered income subject to unemployment insurance contributions reported for the payment date. Calculation rule: Recovered income subject to unemployment insurance contributions (RecoverySubToUnemploymentInsContribution)
Recovered income subject to health insurance contributions (RecoverySubToHealthInsContribution)	irct:decimal2		M	The total recovered income subject to health insurance contributions reported for the payment date. Calculation rule: Recovered income subject to health insurance contributions (RecoverySubToHealthInsContribution)
Sum data by income earner (IncomeEarningsSummary)			M	Summary data of the earnings payment reports submitted for the payment date, itemised by income earner.
Sum data by pension policy number (PensionPolicyNumbersSummary)			M	Sum data of the earnings payment reports submitted for the payment date, itemised by the earnings-related pension provider code and pension policy number.
Sum data by occupational accident insurance policy number (AcclnsPolicyNumbersSummary)			M	Sum data of the earnings payment reports submitted for the payment date, itemised by the occupational accident insurance company identifier and occupational accident insurance policy number.



2.6 Sum data by income earner (IncomeEarningsSummary)

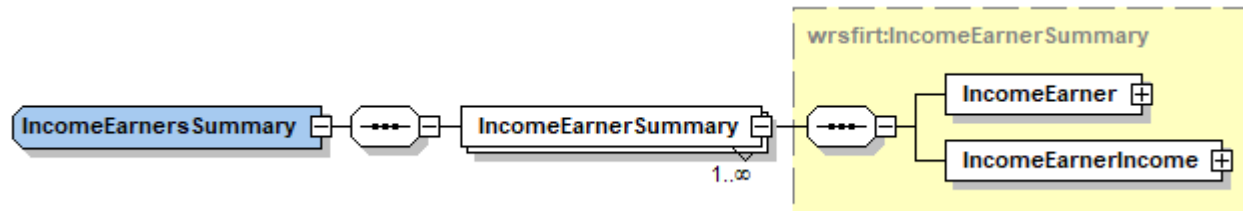

Data group details:

Data designation	Type	Allowed values	V/ M	Processing rule
Sum data by income earner (IncomeEarningsSummary)			M	Sum data of the earnings payment reports submitted for the payment date, itemised by income earner.
Income earner's sum data (IncomeEarnerSummary)			M	<p>Sum data of the earnings payment reports for one income earner.</p> <p>This data group is created for each income earner for which earnings payment reports matching the query criteria specified in the record subscription are found.</p> <p>The sum totals are calculated by income earner as follows:</p> <ol style="list-style-type: none"> The sum totals of the earnings payment reports in which only one identifier has been specified for the income earner are calculated according to the specified identifier. Earnings payment reports in which several identifiers have been specified for the income earner are processed as follows: <ul style="list-style-type: none"> ○ If a Finnish Personal Identification Number has been specified for the income earner, the sums are calculated according to it. ○ Otherwise, the sums are calculated according to the identifier with the lowest Identifier type code. The sums of earnings payment reports in which no identifiers have been specified for the income earner, but the date of birth has been specified, are calculated according to the date of birth. The sums of earnings payment reports in which no identifiers or a date of birth have been specified for the income earner are totalled.
Income earner details (IncomeEarner)			M	The details of the examined income earner.
Income earner's income data (IncomeEarnerIncome)			M	The income earner's income data.



Country name (CountryName)	irct:String70		V	
Date of birth (BirthDate)	xs:date		V/M	The date of birth is distributed if the sum total of the income earner's data has been calculated according to the date of birth.
Income earner is not identified (MissingIdentification)	irct:true	"true"	V/M	This data is distributed if the sum total of the income earner's data has not been calculated according to an identifier or the date of birth.

2.8 Income earner's income data (IncomeEarnerIncome)

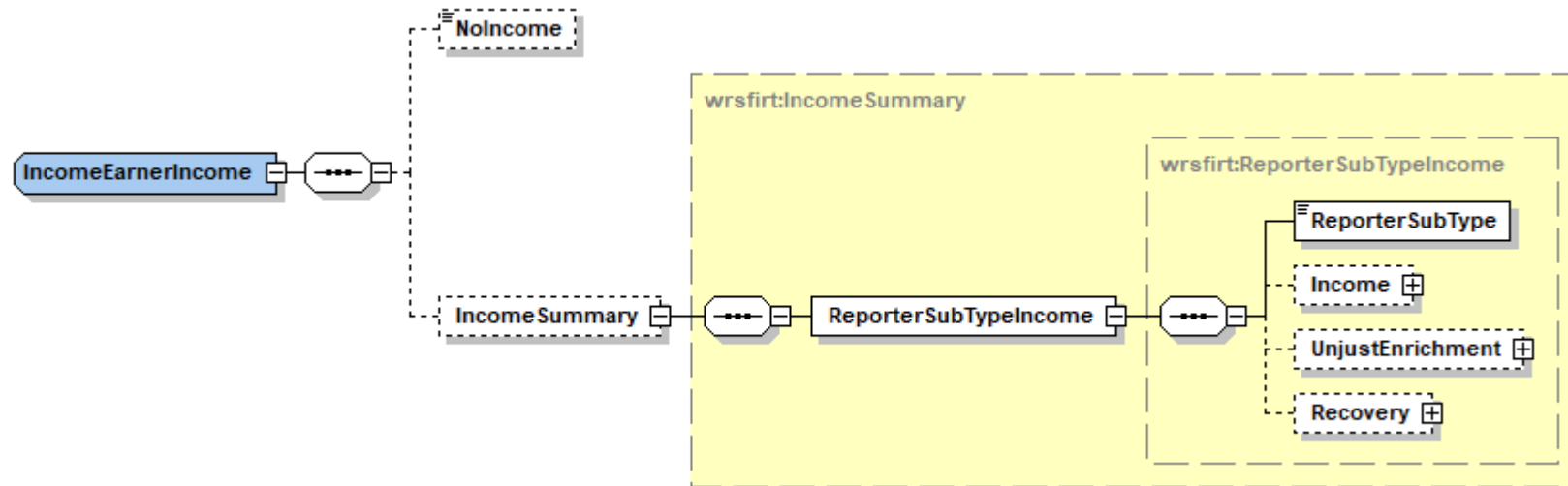

Data group details:

Data designation	Type	Allowed values	V/ M	Processing rule
Income earner's income data (IncomeEarnerIncome)			M	This data is calculated from the earnings payment reports that have been submitted for the examined income earner and the examined payment date. This data group is used to distribute either the Income itemisation data group (if it contains non-zero income data) or the No income data information (if the Income itemisation data group does not contain non-zero income data).
No income data (NoIncome)	irct:true	"true"	V/M	
Income itemisation (IncomeSummary)			V/M	
Submitter type specific income (ReporterSubTypeIncome)			M	<u>Submitter type is "Payer"</u> If the Submitter type query criterion specified in the record subscription is "Payer", the data group is distributed in the record no more than two times: The Submitter type specifier can be "Payer's own payment" or "Payment made by substitute payer".



				<p>The sum totals of the income earner's income, unjust enrichment and recovered payments are calculated according to the Submitter type specifier as follows:</p> <ul style="list-style-type: none"> a. Submitter type specifier is "Payer's own payment": The sum total of the income data is calculated from those reports where the payer (payer specified in the Payer details data group) is the payer specified as the query criterion of the record subscription and the report does not contain substitute payer details (the Substitute payer data group). b. Submitter type specifier is "Payment made by substitute payer": The sum total of the income data is calculated from those reports where the employer specified in the Substitute payer data group (Employer identifier) is the payer specified as the query criterion of the record subscription. <p>This data group is distributed only if it contains non-zero data.</p> <p><u>Submitter type is "Substitute payer"</u></p> <p>If the Submitter type query criterion specified in the record subscription is "Substitute payer", the data group is distributed in the record no more than once: The Submitter type specifier can be "Payment made as substitute payer".</p> <p>The sum totals of the income earner's income, unjust enrichment and recovered payments are calculated according to the Submitter type specifier as follows:</p> <ul style="list-style-type: none"> a. Submitter type is "Payment made as substitute payer": The sum total of the income data is calculated from those reports where the payer (the Payer data group) is the payer specified as the query criterion of the record subscription and the report contains the Substitute payer data group. <p>This data group is distributed only if it contains non-zero data.</p>
Submitter type specifier (ReporterSubType)		Codes: ReporterSubType	M	
Income (Income)			V/M	This data group is distributed only if it contains non-zero data.
Unjust enrichment (UnjustEnrichment)			V/M	This data group is distributed only if it contains non-zero data.
Recovered payments (Recovery)			V/M	This data group is distributed only if it contains non-zero data.

2.9 Income (Income)

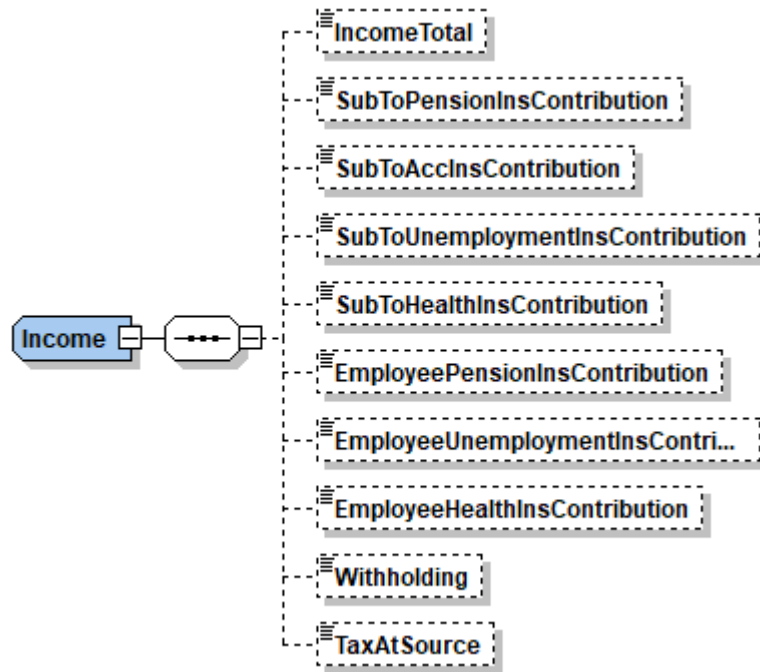

Data group details:

Data designation	Type	Allowed values	V/ M	Processing rule
Income (Income)			V/M	This data group is distributed only if it contains non-zero data. Individual data items are distributed only if they have non-zero values.
Payments total (IncomeTotal)	irct:decimal2		V/M	The income reported for the income earner. Calculation rule: Payments total (IncomeTotal)
Income subject to earnings-related pension insurance contributions (SubToPensionInsContribution)	irct:decimal2		V/M	The income subject to earnings-related pension insurance contributions reported for the income earner.



				Calculation rule: Income subject to earnings-related pension insurance contributions (SubToPensionInsContribution)
Income subject to accident and occupational disease insurance contributions (SubToAccInsContribution)	irct:decimal2		V/M	The income subject to accident and occupational disease insurance contributions reported for the income earner. Calculation rule: Income subject to accident and occupational disease insurance contributions (SubToAccInsContribution)
Income subject to unemployment insurance contributions (SubToUnemploymentInsContribution)	irct:decimal2		V/M	The income subject to unemployment insurance contributions reported for the income earner. Calculation rule: Income subject to unemployment insurance contributions (SubToUnemploymentInsContribution)
Income subject to health insurance contributions (SubToHealthInsContribution)	irct:decimal2		V/M	The income subject to health insurance contributions reported for the income earner. Calculation rule: Income subject to health insurance contributions (SubToHealthInsContribution)
Employee's earnings-related pension insurance contributions (EmployeePensionInsContribution)	irct:decimal2		V/M	The employee's earnings-related pension insurance contributions reported for the income earner. Calculation rule: Employee's earnings-related pension insurance contributions (EmployeePensionInsContribution)
Employee's unemployment insurance contributions (EmployeeUnemploymentInsContribution)	irct:decimal2		V/M	The employee's unemployment insurance contributions reported for the income earner. Calculation rule: Employee's unemployment insurance contributions (EmployeeUnemploymentInsContribution)
Employee's health insurance contributions (EmployeeHealthInsContribution)	irct:decimal2		V/M	The employee's health insurance contributions reported for the income earner. Calculation rule: Employee's health insurance contributions (EmployeeHealthInsContribution)
Withheld taxes (Withholding)	irct:decimal2		V/M	The withheld taxes reported for the income earner. Calculation rule: Withheld taxes (Withholding)
Tax at source (TaxAtSource)	irct:decimal2		V/M	The tax at source reported for the income earner. Calculation rule: Tax at source (TaxAtSource)



2.10 Unjust enrichment (UnjustEnrichment)

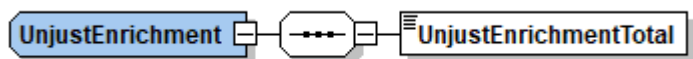

Data group details:

Data designation	Type	Allowed values	V/ M	Processing rule
Unjust enrichment (UnjustEnrichment)			V/M	This data group is distributed only if it contains non-zero data. Individual data items are distributed only if they have non-zero values.
Unjust enrichment total (UnjustEnrichmentTotal)	irct:decimal2		M	Total unjust enrichment reported for the income earner. Calculation rule: Unjust enrichment total (UnjustEnrichmentTotal)

2.11 Recovered payments (Recovery)

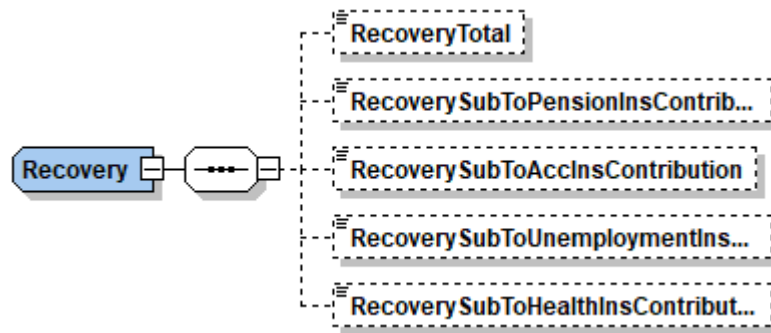

Data group details:

Data designation	Type	Allowed values	V/ M	Processing rule
Recovered payments (Recovery)			V/M	This data group is distributed only if it contains non-zero data. Individual data items are distributed only if they have non-zero values.
Recovered payments total (RecoveryTotal)	irct:decimal2		V/M	Total recovered payments reported for the income earner. Calculation rule: Recovered payments total (RecoveryTotal)
Recovered income subject to earnings-related pension insurance contributions (RecoverySubToPensionInsContribution)	irct:decimal2		V/M	The total recovered income subject to earnings-related pension insurance contributions reported for the income earner. Calculation rule: Recovered income subject to earnings-related pension insurance contributions (RecoverySubToPensionInsContribution)
Recovered income subject to accident and occupational disease insurance contributions (RecoverySubToAcclnsContribution)	irct:decimal2		V/M	The total recovered income subject to accident and occupational disease insurance contributions reported for the income earner. Calculation rule: Recovered income subject to accident and occupational disease insurance contributions (RecoverySubToAcclnsContribution)
Recovered income subject to unemployment insurance contributions (RecoverySubToUnemploymentInsContribution)	irct:decimal2		V/M	The total recovered income subject to unemployment insurance contributions reported for the income earner. Calculation rule: Recovered income subject to unemployment insurance contributions (RecoverySubToUnemploymentInsContribution)



Recovered income subject to health insurance contributions (RecoverySubToHealthInsContribution)	irct:decimal2		V/M	The total recovered income subject to health insurance contributions reported for the income earner. Calculation rule: Recovered income subject to health insurance contributions (RecoverySubToHealthInsContribution)
--	---------------	--	-----	--

2.12 Sum data by pension policy number (PensionPolicyNumbersSummary)

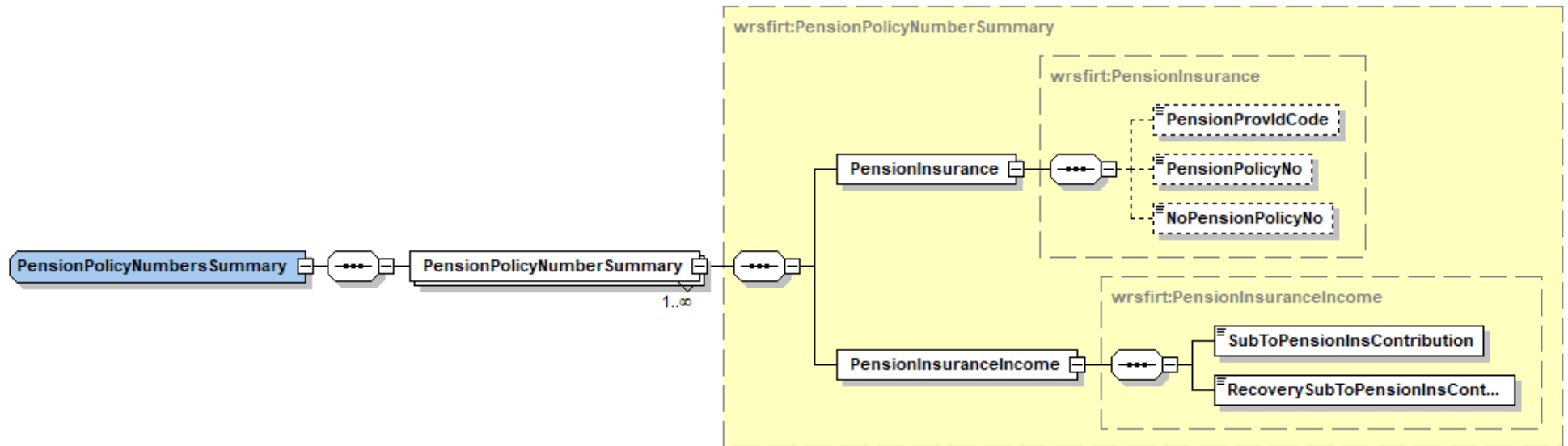

Data group details:

Data designation	Type	Allowed values	V/M	Processing rule
Sum data by pension policy number (PensionPolicyNumbersSummary)			M	Sum data of the earnings payment reports submitted for the payment date, itemised by the earnings-related pension provider code and pension policy number.
Sum data for a pension policy number (PensionPolicyNumberSummary)			M	This data group is created for each (Earnings-related pension provider code, Pension policy number) pair for which earnings payment reports matching the query criteria specified in the record subscription are found. The sum totals are calculated as follows: a. The sum totals of earnings payment reports where the earnings-related pension provider code and pension policy number have been specified are calculated according to them.

				b. The sum total of earnings payment reports in which no earnings-related pension provider code or pension policy number has been specified is calculated.
Earnings-related pension insurance (PensionInsurance)			M	This data group is used to distribute either the Earnings-related pension provider code and Pension policy number data, or the No pension policy number data.
Pension provider code (PensionProvIdCode)	xs:int	Codes: PensionProvIdCode	V/M	
Pension policy number (PensionPolicyNo)	irct:PensionPolicyNo	Pension policy number codes of earnings-related pension providers	V/M	
No pension policy number (NoPensionPolicyNo)	irct:true	"true"	V/M	
Income data (PensionInsuranceIncome)			M	
Income subject to earnings-related pension insurance contributions (SubToPensionInsContribution)	irct:decimal2		M	The total income subject to earnings-related pension insurance contributions reported with the earnings-related pension provider and pension policy number. Calculation rule: Income subject to earnings-related pension insurance contributions (SubToPensionInsContribution) If there is no income, 0 is distributed as the value.
Recovered income subject to earnings-related pension insurance contributions (RecoverySubToPensionInsContribution)	irct:decimal2		M	The total recovered income subject to earnings-related pension insurance contributions reported with the earnings-related pension provider and pension policy number. Calculation rule: Recovered income subject to earnings-related pension insurance contributions (RecoverySubToPensionInsContribution) If there is no income, 0 is distributed as the value.

2.13 Sum data by occupational accident insurance policy number (AccInsPolicyNumbersSummary)

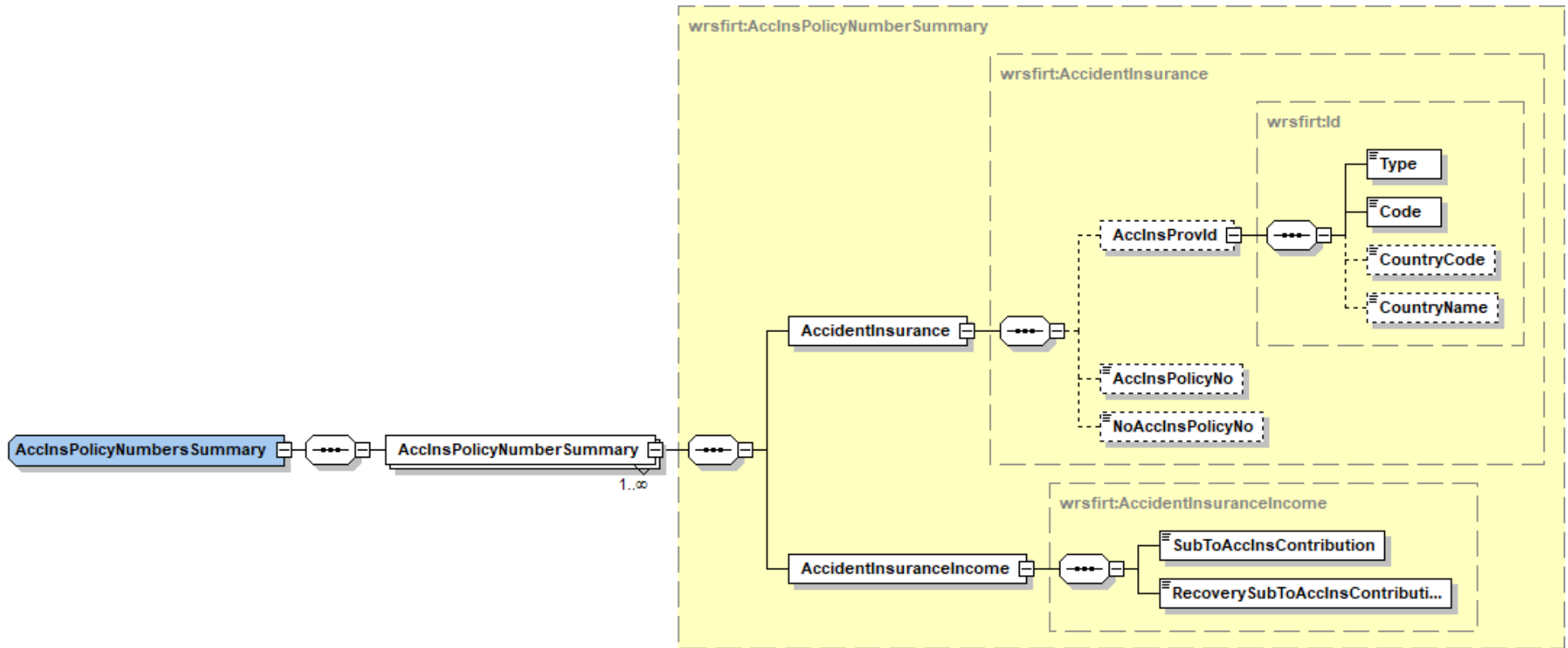

Data group details:

Data designation	Type	Allowed values	V/ M	Processing rule
Sum data by occupational accident insurance policy number (AccInsPolicyNumbersSummary)			M	Sum data of the earnings payment reports submitted for the payment date, itemised by the occupational accident insurance company identifier and occupational accident insurance policy number.

Sum data for an occupational accident insurance policy number (AccInsPolicyNumberSummary)			M	This data group is created for each (Occupational accident insurance company identifier, Occupational accident insurance policy number) pair for which reports matching the query criteria specified in the record subscription are found. The sum totals are calculated as follows: a. The sum totals of earnings payment reports, where the occupational accident insurance company identifier and occupational accident policy number have been specified, are calculated according to them. b. The sum total of earnings payment reports in which no occupational accident insurance company identifier or occupational accident policy number has been specified is calculated.
Occupational accident insurance (AccidentInsurance)			M	This data group is used to distribute either the Occupational accident insurance company identifier and Occupational accident insurance policy number data, or the No occupational accident insurance policy number data.
Occupational accident insurance company identifier (AccInsProvId)			V/M	
Identifier type (Type)	xs:int	Codes: IdType	M	
Identifier (Code)	irct:String30		M	
Country code (CountryCode)	irct:String2	A two-character code in accordance with the ISO 3166 country codes. If the country is unknown, the value "99" is entered.	V/M	
Country name (CountryName)	irct:String70		V/M	
Occupational accident insurance policy number (AccInsPolicyNo)	irct:String20		V/M	
No occupational accident insurance policy number (NoAccInsPolicyNo)	irct:true	"true"	V/M	
Income data (AccidentInsuranceIncome)			M	
Income subject to accident and occupational disease insurance contributions (SubToAccInsContribution)	irct:decimal2		M	The total income subject to accident and occupational disease insurance contributions reported for the occupational accident insurance company identifier and occupational accident insurance policy number. Calculation rule: Income subject to accident and occupational disease insurance contributions (SubToAccInsContribution) If there is no income, 0 is distributed as the value.

Recovered income subject to accident and occupational disease insurance contributions (RecoverySubToAccInsContribution)	irct:decimal2		M	The total recovered income subject to accident and occupational disease insurance contributions reported for the occupational accident insurance company identifier and occupational accident insurance policy number. Calculation rule: Recovered income subject to accident and occupational disease insurance contributions (RecoverySubToAccInsContribution) If there is no income, 0 is distributed as the value.
--	---------------	--	---	--

